



knürr
World of control rooms

CONTROL ROOM SOLUTIONS BOOK

2026 / EN-V1

KNÜRR ERGOCON®

13 to 50



THE ULTIMATE 24/7 CONSOLE FOR CRITICAL OPERATIONS

The new **Knürr Ergocon®** console sets the standard for the most demanding 24-hour deployments in various types of control rooms and control suites:

- Best possible ergonomics, using multidimensional setting options on three axes (table height, monitor height, and viewing distance).
- Solutions for individual areas of application and perfect device integration from a wide variety of console models.

- In combination with Knürr® Ergocontrol, each user can have customized settings. This free seating concept guarantees efficient workstation ergonomics.

With many years of experience in equipping mission-critical control centers, our Knürr workstation experts design perfectly adapted workstations for emergency service organizations such as fire departments, rescue services, disaster and civil protection, police, as well as for private security centers.

Knürr Ergocon®

with new KVM-ready technology cabinet

Intelligent cable routing

Cables are routed in a roomy and hidden vertical support on the side of the table, accessible from both inside and out.

High-quality desk tops

- Available in rectangular and curved designs
- Single-level or bi-level work surface.
- Framed by ergonomic and heavy-duty Knürr ErgoSoft edging.



Modular console system

Choice between four different base frame widths

- 1400 mm
- 1800 mm
- 2200 mm
- 2x1400 mm for extra-large consoles

Standard compliance

- DIN EN ISO 11064: Ergonomic design of control centers
- DIN EN 527 defines workstation types with minimum requirements for range of settings:
Type A: min. 650 to 1,250 mm
Type D: min. 680 to 1,180 mm
We fulfill both requirements!*

Stability and design

Stable c-base frame for maximum legroom.
Optional colored decorative strips made of extruded aluminum for a personal touch.

* Depending on the corresponding console design

Modern colors

Base frame in RAL 9006 White aluminium. Tabletop, decorative strips, and wood trim on technology cabinet available in six different designs.

Secure monitor connection

Highest flexibility using single-level and two-level monitor rails, with the option of motorized height and depth adjustment.

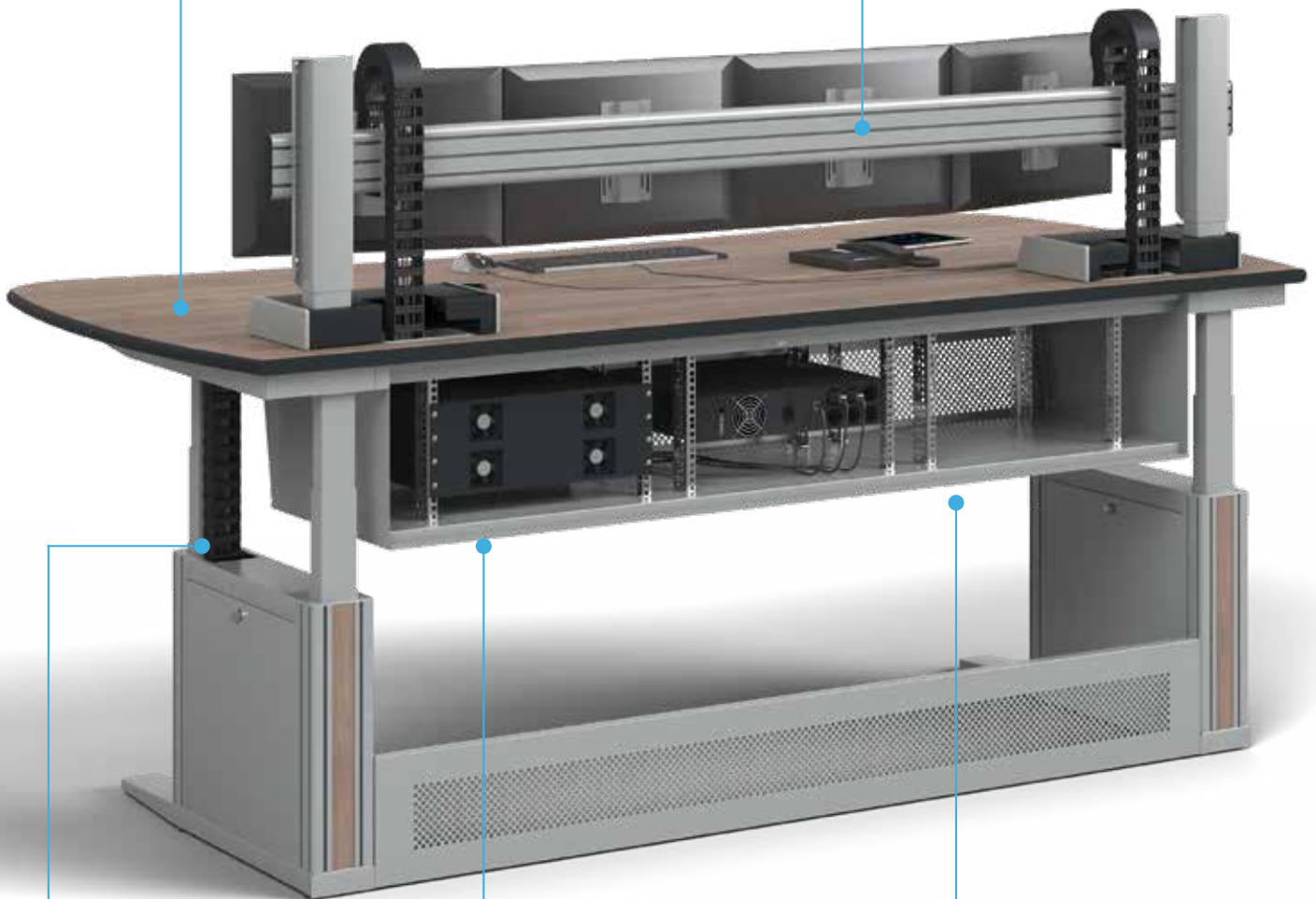

Comfortable height adjustment

Simple height adjustment for working and monitor levels, with memory function (standard).

Integrated passive ventilation concept

Guarantees maximum reliability of IT components.

KVM-ready technology cabinet

With up to 3x6 RU 19" installation space for the perfect integration of KVM switches, SFF-PC, power distribution, cable management accessories, and much more.

Knürr Ergocon®

The right console for your specific application!

To keep up with the growing requirements for control center consoles, we have developed the new Knürr Ergocon® console in three different designs:

The common element is the new multifunctional side compartment.

Clever side compartment with multiple features:

Collision protection

using integrated piezoelectric sensors.

Secure cable routing

for optimal bending.

Various installation options

Integration of data and power transfer points using the corresponding Knürr accessories.

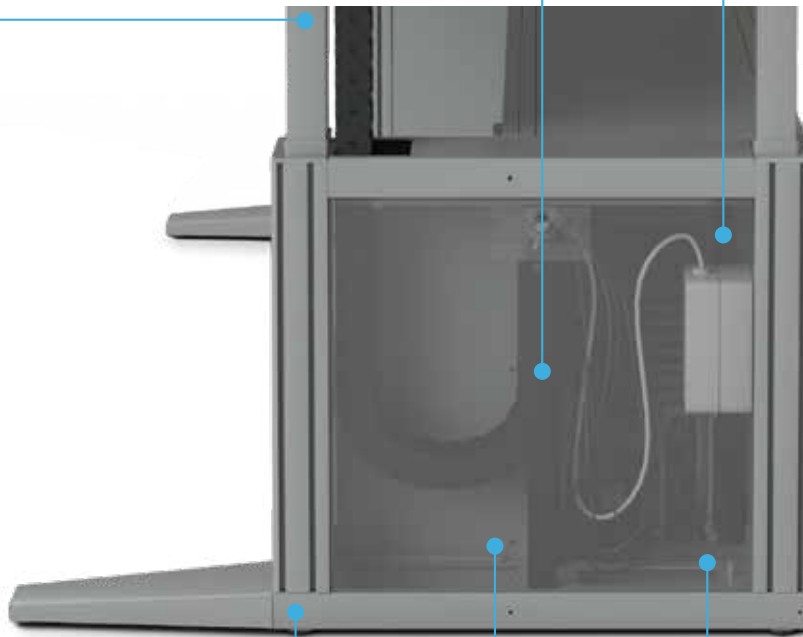

Complete grounding concept

Maximum accessibility

for maintenance purposes, with removable side covers (optionally lockable).

Concealed cables

through raised floor and spacious openings.

1 Installation module

Area of application:
Technical integration with
max. 3x1 RU 19" installation space
under the tabletop, typical for video
extender applications.



2 KVM-ready technology cabinet

Area of application:
Up to 3x6 RU for integrating
technology, typical for KVM
applications, SFF or micro-
workstations.



3 Workstation technology cabinet in base

Area of application:
Maximum technical integration for
tower or 19" workstation requiring
much space, typical for powerful
servers and rack-mounted equipment
directly on the console.



Rectangular consoles:



Application:

Especially suited for efficient setups in rows in front of large-format screens on a wall.

A single console can also be efficiently placed into the existing infrastructure, saving space due its rectangular shape. Rectangular workstations are especially recommended for changing activities between manual writing work and computer-supported work. Our rectangular consoles are available not only in a single-level design, but also as a bi-level table, with the rear level able to drop down 70 mm.

To meet your specific requirements, you have a choice between **four different widths**:

- **1600 mm**
(base width 1400 mm)
- **2000 mm**
(base width 1800 mm)
- **2400mm**
(base width 2200mm)
- **3000 mm**
(base width 2x1400 mm)



Single-level work surface

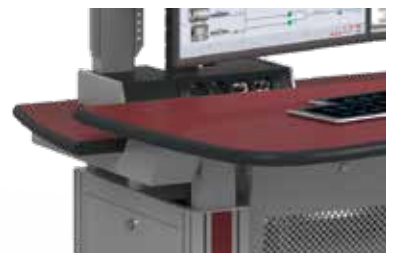

Bi-level work surface

Dimensions:

Single-level work surface:

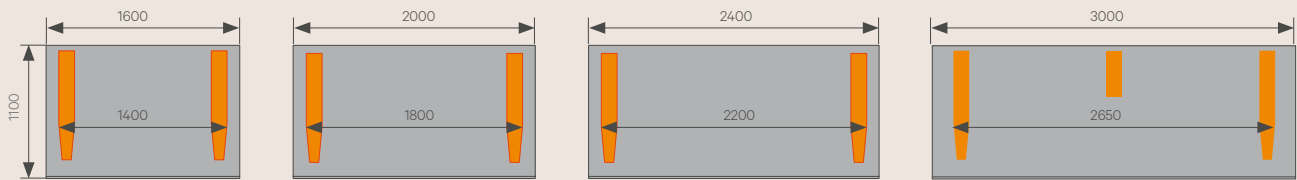

Bi-level work surface:

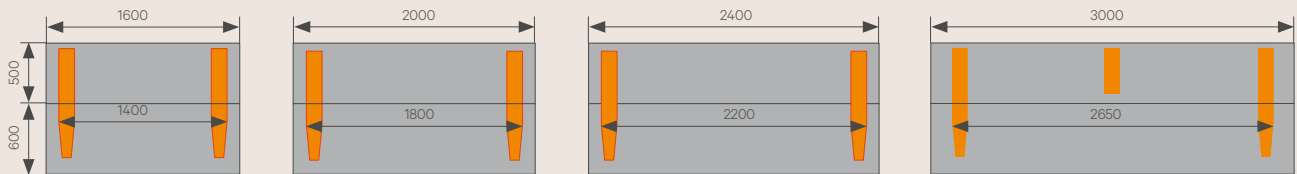

Curved consoles:



Convex arrangement,
large radius



Convex arrangement,
small radius



Concave arrangement

Application:

Especially suited for circular arrangement of consoles in control rooms.

The innovative curved tabletops offer clear advantages: They can be arranged in various curve shapes, whether tight or open, concave or convex.

For single consoles, the ergonomically rounded tabletops play a significant role in reducing the risk of hitting table corners in heavily trafficked control rooms.

Our curved consoles are also available in a single-level design, as well as a bi-level table, with the rear level capable of lowering 70mm. To meet your specific requirements, you have a choice between **four different widths**:

- **1800 mm**
(base width 1400 mm)
- **2200mm**
(base width 1800mm)
- **2600mm**
(base width 2200mm)
- **3100 mm**
(base width 2x1400 mm)

Dimensions:

Single-level work surface:

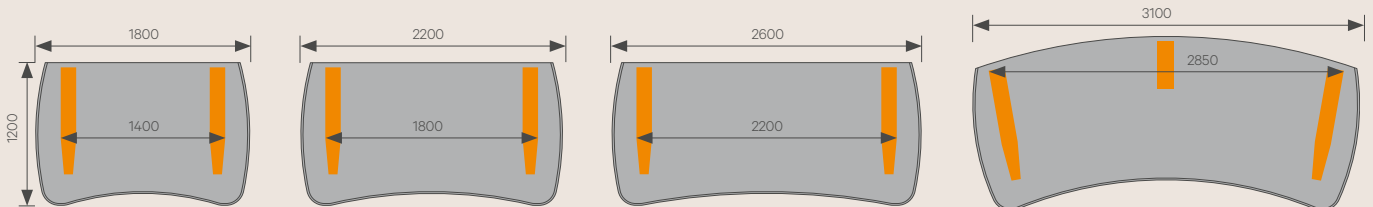

Bi-level work surface:

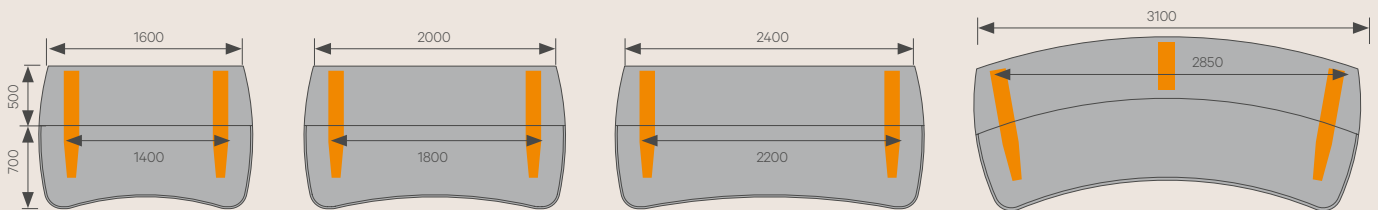

Monitor levels:

The monitor level is the main element found above the working surface. To offer the user optimal ergonomics,

Knürr has three different designs for monitor placement:

1. Heightfix (H-Fix)



Hfix single-level



Hfix two-level

2. Height-adjustable (H-A)



H-A single-level



H-A two-level

3. Height/depth-adjustable (H/D-A)



H/D-A single-level



H/D-A two-level

1. Heightfix (H-Fix):

The horizontal function rail with integrated cable duct guarantees secure and stable monitor mounting. This allows the tabletop below the monitor to remain free for other devices or desk attachments. Large-volume energy chains provide for protected and orderly cable routing.

The patented multi-function unit establishes the basic framework for any monitor mount. It incorporates functions such as concealed

cable routing and mounting for the vertical columns (as well as the optional Knürr-DICON personal docking units).

2. Height-adjustable (H-A):

Above and beyond the functions of the H-Fix monitor level, the H-A version offers infinitely variable electrical height adjustment for monitors. Secure operation is always certain with the integrated piezoelectric sensors for collision protection.

3. Height- and depth-adjustable (H/D-A):

In addition to the functions of the H-Fix and H-A monitor levels, this version is equipped with completely concealed, electrical depth adjustment. This allows the user to adjust all levels as they see fit for the best possible ergonomics and the optimal viewing distance to the monitors.

Knürr® multi-function unit:

Concealed cable duct
from the technical area to the
monitor level.

Large-volume energy chain

for protected cable routing and optimal
bending radius.

Lifting column
with mounts for monitor rails.

Knürr® multi-function unit

Knürr®-DICON module

for customizing with power and
data modules.



Colors:



- Tabletop in **RAL7035, Light grey**
- Sheet metal parts and aluminum profiles in **RAL9006, White aluminium**

Depending on design:

- Installation module or KVM technology cabinet in RAL9006, White aluminium
- Workstation technology cabinet in base in RAL9006, White aluminium

.A



- Tabletop in **Nelson oak wood pattern**
- Sheet metal parts and aluminum profiles in **RAL9006, White aluminium**

Depending on design:

- Installation module or KVM technology cabinet in RAL9006, White aluminium
- Workstation technology cabinet in base in RAL9006, White aluminium with front panel in **Nelson oak wood pattern**

.B



- Tabletop in **Pine black wood pattern**
- Sheet metal parts and aluminum profiles in **RAL9006, White aluminium**

Depending on design:

- Installation module or KVM technology cabinet in RAL9006, White aluminium
- Workstation technology cabinet in base in RAL9006, White aluminium with front panel in **Pine black wood pattern**

.C



- Tabletop in **Nano bronzo doha**
- Sheet metal parts and aluminum profiles in **RAL9006, White aluminium**

Depending on design:

- Installation module or KVM technology cabinet in RAL9006, White aluminium
- Workstation technology cabinet in base in RAL9006, White aluminium

.D



- Tabletop in **Beech wood pattern**
- Sheet metal parts and aluminum profiles in **RAL9006, White aluminium**

Depending on design:

- Installation module or KVM technology cabinet in RAL9006, White aluminium
- Workstation technology cabinet in base in RAL9006, White aluminium with front panel in **Beech wood pattern**

.E



- Tabletop in **Maple wood pattern**
- Sheet metal parts and aluminum profiles in **RAL9006, White aluminium**

Depending on design:

- Installation module or KVM technology cabinet in RAL9006, White aluminium
- Workstation technology cabinet in base in RAL9006, White aluminium with front panel in **Maple wood pattern**

.F

Decorative panels:



**RAL7021,
Black grey**



**Nelson oak
wood pattern**



**Pine black
wood pattern**



**Nano bronzo
doha**



**Beech wood
pattern**



**Maple wood
pattern**



**Individual
corporate
logo**



Knürr Ergocon®

Configurator



The possibilities are impressive!

Over 2,000 variations are available, using the configurable part numbers.

This lets you put together the perfect console, designed specifically to meet your tastes and requirements.

You can include an installation module, KVM-ready technology cabinet in the base, workstation technology cabinet in base, rectangular or curved tabletop, single-level or bi-level design, and up to two-level monitor rails with depth adjustment.

You will always find the right Knürr console for your particular application!

Using the **Knürr Ergocon® configuration table**, you can specify the console that is best for you.

Part no.: 04.500.



Base widths	Tabletop shape	Monitor level	Color
A = Knürr Ergocon® 1400 Installation module	0 = Rectangular	0 = without	A = RAL 7035
B = Knürr Ergocon® 1400 KVM-ready	1 = Rectangular, bi-level	1 = H-Fix single-level	B = Nelson oak
C = Knürr Ergocon® 1400 Workstation	2 = Curved	2 = H-Fix two-level	C = Pine black
D = Knürr Ergocon® 1800 Installation module	3 = Curved, bi-level	3 = H-A single-level	D = Nano bronzo doha
E = Knürr Ergocon® 1800 KVM-ready		4 = H-A two-level	E = Beech
F = Knürr Ergocon® 1800 Workstation		5 = H/D-A single-level	F = Maple
G = Knürr Ergocon® 2200 Installation module		6 = H/D-A two-level	
H = Knürr Ergocon® 2200 KVM-ready			
I = Knürr Ergocon® 2200 Workstation			
J = Knürr Ergocon® 2x 1400 Installation module			
K = Knürr Ergocon® 2x 1400 KVM-ready			
L = Knürr Ergocon® 2x 1400 Workstation			

Sample configuration (see image, left):

Frame width: 2200 mm, workstation, technical substructure
 Tabletop: curved, single-level
 Monitor level: height/depth-adjustable, single-level
 Tabletop color: RAL7035, Light grey



Base widths	Tabletop shape	Monitor level	Color
I	2	5	A



Configuration number: 04.500.I25.A

Accessories

Flat display mount, decorative panels, and integrated technology



Flat display mount

- Flat display mount for displays with VESA mount, 100 mm
 - With integrated cable duct
 - For mounting on Knürr IM function rail
 - Integrated quick-mount system
- **Supply schedule**
 - 1x flat display mount
 - with height compensation plate
 - Fasteners
 - **Material / Surface Type D-G**
 - Swivel arms: Die-cast aluminum, powdered RAL 9006 White aluminium
 - Adapter: Sheet steel powdered smooth, RAL9006 White aluminium
 - Covers on monitor arms: Plastic, clear
 - **How supplied**
 - In sets



Version	Height compensation plate	Load capacity	Order-no.	UP
Type IM short (140 mm)	•	15 kg	04.501.010.7	1 unit
Type IM medium (140+150 mm)	•	15 kg	04.501.011.7	1 unit
Type IM long (140+200 mm)	•	15 kg	04.501.012.7	1 unit
Type IM double (140+200+150 mm)	•	15 kg	04.501.013.7	1 unit

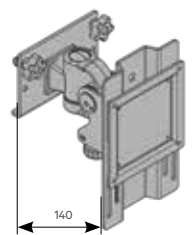

Flat display mount IM short

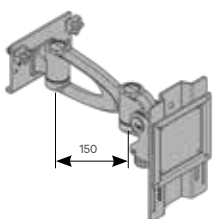

Flat display mount IM medium

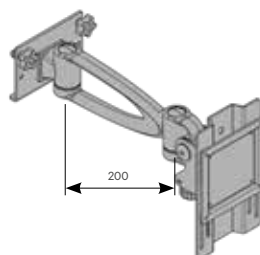

Flat display mount IM long

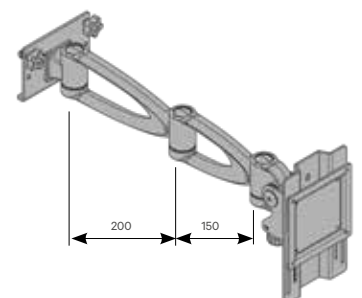

Flat display mount IM double

Decorative panels

- For customized design of Ergocon aluminum profiles

- **Supply schedule**
 - 1 decorative panel

Version	Order-no.	UP
RAL7035, Light grey	04.501.004.A	1 unit
Nelson oak wood pattern	04.501.004.B	1 unit
Pine black wood pattern	04.501.004.C	1 unit
Nano bronzo doha	04.501.004.D	1 unit
Beech wood pattern	04.501.004.E	1 unit
Maple wood pattern	04.501.004.F	1 unit
RAL7021, Black grey	04.501.004.G	1 unit



RAL7035, Light grey



Nelson oak wood pattern



Pine black wood pattern



Nano bronzo doha



Beech wood pattern



Maple wood pattern



RAL7021, Black grey



Individual corporate logo

Dimensions in mm: W = width
H = height
D = depth
h = installation height
t = usable depth
L = length

RU = Number of standard height units. 1 RU = 44.45 mm
19" = 482.6 mm,
(suited to 19" installation acc. to DIN 41494)

UP = Unit of packaging
kg = weight

Conversion: 1 inch = 25.4 mm
1 pound = 453.6 g

Replace 'x' with the last digit of your color choice

Knürr®-Dicon for multi-function unit

- Suitable for integration in the Ergocon multi-function unit
- Customizable power and data supply unit
- Available in three country versions (DE-Germany, F-France, CH-Switzerland) with two or three power outlets (for CH: one or two)
- Flexible equipping of data module elements using keystone mounts
- **Material/surface**
 - Housing: closed sheet steel profile, galvanized, powder-coated structure
 - Plastic parts: Vampamid 6 0024 VO (UL94), recyclable
 - Center core: continuous power rails, brass
- **Approvals/certificates**
 - CE label in accordance with:
 - Low-voltage guideline 2014/35/EU
 - EMC guideline 2014/30/EU
 - RoHS guideline 2011/65/EU
 - Bureau Veritas BG certificate (factory inspection)
 - Bureau Veritas CB certificate
- **Colors**
 - Housing: RAL 9005 Jet black microstructure
 - Plastic parts: black
- **Load capacity**
 - 100–240 V AC/16 A (Schuko and France)
 - 100–240 V AC/10 A (Switzerland)
- **Supply schedule**
 - 1 power outlet strip
 - 2 fastening brackets

Model	Input values		Input plug	Outputs			Data modules	Part No.
	Voltage	Current		DE Schuko	F UTE	CH Type 13		
4x	230 V	16 A	GST-18	2			2	03.300.022.8
4x	230 V	16 A	GST-18		2		2	03.400.022.8
4x	230 V	16 A	GST-18			1	2	03.701.012.8
4x	230 V	16 A	GST-18			2	1	03.701.021.8



4x unit Schuko



4x unit French (UTE)



4x unit Switzerland (Type 13) with 10 A fuse

Knürr®-Dicon mounting plates and Keystone modules

Mounting plate simple	03.322.054.8
Mounting plate 1x Keystone	03.322.055.8
Mounting plate 2x Keystone	03.322.056.8
Mounting plate 1x VGA	03.322.057.8
Keystone module USB 3.0	03.322.058.1
Keystone module RJ45 Cat.6A	03.322.059.1
Keystone module HDMI	03.322.060.1
Keystone module AUDIO 3.5 mm 4-pin stereo	03.322.061.1
Keystone module VGA	03.322.062.1

Version: Socket – socket for all modules

	USB 3.0	RJ 45	HDMI	Audio	VGA
Mounting plate 1x Keystone	1x	1x	1x	1x	-
Mounting plate 2x Keystone	2x	2x	2x	2x	-
Mounting plate 1x VGA	-	-	-	-	1x



Mounting plate simple



Mounting plate 1x Keystone



Mounting plate 2x Keystone



Mounting plate 1x VGA

Supply cable for Knürr®-DICON unit

- Network plug CEE/VII - GST 18 socket (Wieland)
- Line H05VV-F3G 1.5 mm²
- **Color**
 - White

- **Note**

- Please find further Knürr Dicon versions for worktop integration on page 207.

L	Order-no.	UP
2.0 m	04.000.040.0	1 unit
5.0 m	04.000.041.0	1 unit



DOS00467

Data transfer point RJ45

- Suited for the installation of up to five RJ45 keystone elements.
- For simple attachment in Ergocon side compartment.
- **Material/surface**
 - Sheet steel, powder-coated RAL9006, White aluminium

- **Supply schedule**

- 1x mounting bracket with fasteners

- **How supplied**

- In sets

- **Note**

- Please order the accompanying Keystone elements separately.

Version	Order-no.	UP
Data transfer point	04.501.035.7	1 unit
Keystone module RJ45 Cat.6A	03.322.059.1	1 unit



Support bracket for power distributor

- Suitable for installation of max. 2 Knürr® 19" DI strip PDUs or a power distributor box.
- For simple attachment in Ergocon side compartment.
- **Material/surface**
 - Sheet steel, powder-coated RAL9006, White aluminium

- **Supply schedule**

- 1x support bracket with fasteners

- **How supplied**

- In sets

- **Note**

- Please order power distribution units separately.

Version	Order-no.	UP
Support bracket	04.501.036.7	1 unit



Dimensions in mm: W = width
H = height
D = depth
h = installation height
t = usable depth
L = length

RU = Number of standard height units, 1 RU = 44.45 mm
19" = 482.6 mm,
(suited to 19" installation acc. to DIN 41494)
UP = Unit of packaging
kg = weight

Conversion: 1 inch = 25.4 mm
1 pound = 453.6 g

Replace 'x' with the last digit of your color choice

Accessories

Suitable for consoles with workstation technology cabinet in base!

19" Mounting-Set 6 RU

- Suitable for consoles with workstation technology cabinet in base
- Space saving installation of 19" equipment like patch panels, switches or socket strips
- Assembly of equipment on 19" profile using hole matrix and cage nuts
- **Material**
 - Sheet steel, powder-coated
- **Supply schedule**
 - 1x 19" Mounting-Set 6 RU
 - Mounting material
- **How supplied**
 - In sets
- **Note**
 - Please order suitable fastening materials for 19" components separately.



Version	Order-no.	UP
19" Mounting-Set, 6 RU	04.501.039.7	1 unit

19" swivel frame, 4 RU

- Suitable for consoles with workstation technology cabinet in base
- Attachment for 19" swivel frame on the floor frame of the technology cabinet in the workstation base using depth members
- Assembly of equipment on 19" profile using hole matrix and cage nuts
- **Material/surface**
 - Sheet steel, powder-coated, RAL7021, Black grey
- **Supply schedule**
 - 1x 19" frame
- **How supplied**
 - Pre-mounted
- **Note**
 - Please order suitable fastening materials for 19" components separately.



Version	Order-no.	UP
19" swivel frame, 4 RU	04.501.040.8	1 unit

Extension Module for workstation technology cabinet

- Suitable for consoles with workstation technology cabinet in base.
- Extension of workstation technology cabinet by 200mm in depth to create space for equipment with larger depth.
- **Material**
 - Sheet steel, powder-coated
- **Surface**
 - RAL9006, White Aluminum
- **Supply schedule**
 - 1 Extension module
 - Mounting material
- **How supplied**
 - In sets

Version	Order-no.	UP
Extension module 200mm W1400	04.501.070.7	1 unit
Extension module 200mm W1800	04.501.071.7	1 unit
Extension module 200mm W2200	04.501.072.7	1 unit



Cable bridge

- Suitable for consoles with technology cabinet in workstation base
- **Material**
 - Cable bridge, steel, coated
- **Supply schedule**
 - 1x cable bridge with fasteners
- **How supplied**
 - In sets
- **Dimensions**
 - Height 60 mm, depth 60 mm length fits to technology cabinet in the base

Version	Order-no.	UP
For base width 1400 mm	04.501.030.9	1 unit
For base width 1800 mm	04.501.031.9	1 unit
For base width 2200 mm	04.501.032.9	1 unit



19" frame, 8 RU

- Suitable for consoles with technology cabinet in workstation base
- 19" frame for attachment of 19" components and mounting plates
- Attachment of 19" frame on the floor frame of the technology cabinet in the workstation base using depth members, thereby adjustable
- Mounting equipment on 19" profile using t-slots and speed nuts, thereby allowing infinite height adjustment
- **Material**
 - 19" adapter plate and frame cover made of sheet steel (powder-coated structure)
 - 19" profile made of extruded aluminum, blank
- **Surface**
 - Adapter plate RAL 9011, Graphite black
- **Supply schedule**
 - 1 adapter plate
 - 1 frame cover
 - 2 depth members
 - 2 19" profiles
- **How supplied**
 - Pre-mounted
- **Dimensions**
 - Please order suitable fastening materials for 19" components with order (see page 183).

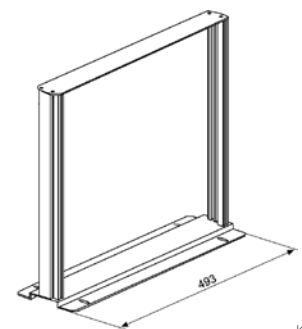

KON20032

Version	Order-no.	UP
19" frame, 8 RU	04.412.650.7	1 unit

Dimensions in mm: W = width
H = height
D = depth
h = installation height
t = usable depth
L = length

RU = Number of standard height units, 1 RU = 44.45 mm
19" = 482.6 mm, (suited to 19" installation acc. to DIN 41494)
UP = Unit of packaging
kg = weight

Conversion: 1 inch = 25.4 mm
1 pound = 453.6 g

Replace 'x' with the last digit of your color choice

19" accessories

Suitable for consoles with KVM-ready technology cabinet!



Folding footrest for Knürr Ergocon

- Suitable for Ergocon console with installer module or KVM Ready technology substructure
- Optimal ergonomic supplement for even more comfortable work
- Hinged version with lateral cable entry into the side panels
- Additional 19" area (up to 3x 1U) below the footrest for installing e.g. patch panels, switches, etc.
- Locking option for service position

- **Supply schedule**
 - 1 footrest
 - 2 side covers



Version	Order-no.	UP
Footrest W1400 foldable	04.501.180.7	1 unit
Footrest W1800 foldable	04.501.181.7	1 unit
Footrest W2200 foldable	04.501.182.7	1 unit
Footrest 2x W1400 curved 20° foldable	04.501.183.7	1 unit

19" shelf, 1RU

- For mounting in the 19" KVM Ready technology substructure or also in the installation module
- Mounting material included
- **Material**
 - Sheet steel 1.5 mm
- **Load capacity**
 - 20 kg static
- **Supply schedule**
 - 1 shelf
 - Mounting material

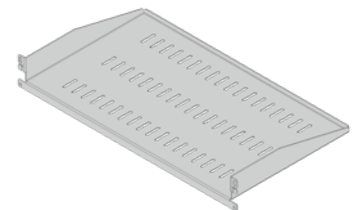

W	H	W x L	Version	Order-no.	UP
482.6	50	442 x 260	RAL7035 Light grey	04.501.038.1	1 unit
482.6	50	442 x 260	RAL7021 Black grey	04.501.038.8	1 unit

19" cable routing plate, 1 RU

- For orderly cable routing.
- **Material/surface**
 - Type 1: Front plate sheet steel 1.5 mm, powder-coated.
- **Color**
 - RAL 7035 Light grey
- **Outer dimensions**
 - **Cable routing:**
 - Type 1: 55 x 22 mm, plastic
- **Supply schedule**
 - 1 19" front plate
 - 5 cable routers
- **How supplied**
 - Pre-mounted
- **Note**
 - When ordering, please also order suitable front plate fasteners

W	RU	Mount depth	Version	Order-no.	UP
483	1	from 80 mm	Type 1	05.040.111.1	1 unit

Fillister head screw

- IEC DIN 967
- **Supply schedule**
 - 50 fillister head screws, Form Z
- **How supplied**
 - In sets

W	H	D	Version	Order-no.	UP
			M5 x 10	05.041.330.9	1 set
			M5 x 16	05.041.331.9	1 set
			M6 x 10	05.041.332.9	1 set
			M6 x 16	05.041.333.9	1 set

Cage nuts

- Clips into profiles with hole matrix
- **Supply schedule**
 - 50 cage nuts, sheet metal, 1.5mm
- **How supplied**
 - In sets

Version	Order-no.	UP
M5: sheet metal, 1.5 mm	05.041.513.7	1 set
M6: sheet metal, 1.5 mm	05.041.514.7	1 set



Type 1

MEC00110



Type 1

MEC20103



MEC20140



MEC20139

Link-up container and link-up duct

Knürr Ergocon® Link-up container

- Basic body of link-up container with storage compartment H150mm and garage for Ergocon mobile drawer unit
 - Generous technical module with 19" frame in the rear area
 - Removable perforated rear panel (optionally lockable or with push lock)
 - Link-up duct on both sides for lateral connection to the Knürr Ergocon® console for optimised cabling
 - Removable top cover on link-up ducts for best accessibility
 - Free-form table top with high-quality HPL coating and all-round ABS edge banding
- **Material**
 - Link-up container:
 - Basic body: Wooden corpus, coated
 - Tabletop: HPL coated with ABS edging
 - Removable rear panel
 - Sheet steel, powder coated
 - **Surface**
 - Basic body, rear panel and link-up ducts completely in RAL9006, White Aluminum
 - Tabletop .A in RAL7035, Light Grey, ABS edging in black (Different tabletop colors are available to match the console design)
 - **Supply schedule**
 - 1 Link-up container
 - 1 Tabletop
 - 2 Link-up ducts
 - **How supplied**
 - Pre-mounted.
 - **Note**
 - The overall dimensions, the tabletop shape and the tabletop colour vary depending on the project.
 - Please order suitable roller containers or shelves separately.

Version	Order-no.	UP
Link-up container 1 module 20° convex	04.501.080.A	1 unit
Link-up container 2 modules 20° convex	04.501.081.A	1 unit
Storage shelf for link-up container	04.501.085.7	1 unit



Knürr Ergocon® Link-up duct

- Link-up duct for connection of two Knürr Ergocon® consoles.
 - Removable top cover on link-up ducts for best accessibility and optimised cabling
- **Material**
 - Cover panels: Wooden elements, coated
 - Mounting brackets: sheet steel, powder coated
 - **Surface**
 - RAL 9006, White Aluminum
- **Dimensions**
 - Project specific
 - **Supply schedule**
 - 1 Link-up duct
 - Mounting Material
 - **How supplied**
 - In sets

Version	Order-no.	UP
Link-up duct, straight version	04.501.090.7	1 unit
Link-up duct, 20° convex version	04.501.091.7	1 unit

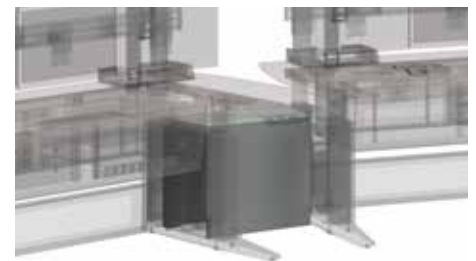

Dimensions in mm: W = width
 H = height
 D = depth
 h = installation height
 t = usable depth
 L = length

RU = Number of standard height units, 1 RU = 44,45 mm
 19" = 482,6 mm,
 (suited to 19" installation acc. to DIN 41494)
 UP = Unit of packaging
 kg = weight

Conversion: 1 inch = 25,4 mm
 1 pound = 453,6 g
 Replace 'x' with the last digit of your color choice

WARRANTY & MAINTENANCE PACKAGES

ESSENTIAL



SCOPE OF SERVICES:

- **24/7 service hotline** – available at all times for rapid support from our experts
- **Reliable fault rectification** – service call-out within a maximum of 10 working days
- **Replacement parts included** – no additional material costs in the event of a fault

Knürr® Warranty – ESSENTIAL

Description	Order-nr.
Warranty 24 months (2Y)	94.000.024.0
Warranty 36 months (3Y)	94.000.036.0
Warranty 48 months (4Y)	94.000.048.0
Warranty 60 months (5Y)	94.000.060.0

Knürr® proactive on-site maintenance

Description	Order-nr.
Maintenance	94.001.000.0
Maintenance with DGUV/V3	94.001.000.0000001
Maintenance with Thermoscan	94.001.000.0000002

*In accordance with Knürr warranty terms and conditions

PREMIUM



SCOPE OF SERVICES:

- **24/7 service hotline** – available at all times for rapid support from our experts
- **Reliable fault rectification** – service call-out within a maximum of 5 working days
- **Replacement parts included** – no additional material costs in the event of a fault
- **On-site repairs included** – travel costs and labour costs are already included in the service package

Knürr® Warranty – PREMIUM

Description	Order-nr.
Warranty 24 months (2Y)	94.000.024.1
Warranty 36 months (3Y)	94.000.036.1
Warranty 48 months (4Y)	94.000.048.1
Warranty 60 months (5Y)	94.000.060.1
Warranty 72 months (6Y)	94.000.072.1
Warranty 84 months (7Y)	94.000.084.1
Warranty 96 months (8Y)	94.000.096.1
Warranty 108 months (9Y)	94.000.108.1
Warranty 120 months (10Y)	94.000.120.1

Ergonomically designed products and solutions from a single source

Knürr GmbH is one of the world's leading specialists for innovative solutions in safety- and performance-critical control centres and command rooms. For more than 50 years, the company, headquartered in Germany, has been delivering tailor-made and fully integrated workspace systems designed for demanding 24/7 operations.

Learn more about Knürr solutions and services at www.knuerr.com

Knürr GmbH
 Mariakirchener Straße 38
 94424 Arnstorf
 Germany
 T +49 8723 28 0
 F +49 8723 28 138
 info@knuerr.com
 www.knuerr.com



knürr
World of control rooms

knuerr.com | **Knürr GmbH**, Mariakirchener Straße 38, 94424 Arnstorf, Germany ID-Nr. DE 363797731

© 2026 Knürr GmbH. All rights reserved. Knürr® and the Knürr logo are trademarks or registered trademarks of Knürr GmbH. All other names and logos referred to are trade names, trademarks or registered trademarks of their respective owners. While every precaution has been taken to ensure accuracy and completeness herein, Knürr GmbH assumes no responsibility, and disclaims all liability, for damages resulting from use of this information or for any errors or omissions. Specifications are subject to change without notice.

09.991.116.0.000001 • EN • #10065 Version 19.03.2026