



knürr
World of control rooms

CONTROL ROOM SOLUTIONS BOOK

2026 / EN-V1

KNÜRR DACOBAS® SYSTEM TABLES

128 to 148



Knürr Dacobas®-System tables Strong points

Office organisation and technical integration are enabled with a wide range of individual, configurable desk pedestals.

- 1 Desks are afforded a high load rating with a strong (50 mm) steel frame and a postformed desktop (70 mm).
- 2 The patented quick connect system guarantees simple and strong link-up of desk, cabinet and corner elements.
- 3 Tapped thread in the top end of the extrusion allows adapters to be mounted for practical accessories.
- 4 Additional work and storage surfaces are created with desktop superstructures. A simple plug/screw connection enables vertical link-up for workstation superstructures, e.g. a second working level or lighting fixtures.
- 5 Cable Routing Set (CRS)
Quick and easy cabling with the cable routing set in the vertical cable duct under the worktop.

All workstations are also available in ESD version as required.



1 DAC00251



2 DAC00262



3 DAC00259



4 DAC00387



5 DAC20184

Dimensions in mm:	W = Width H = Height D = Depth h = Installation height d = Useful depth L = Length	HU = Standard height unit, 1 HU = 44.45 mm 19" = 482.6 mm. (ideal for 19" components in acc. with DIN 41494) UP = Unit of packaging
Conversion:	1 inch = 25,4 mm	Replace „x“ with the number of your color choice

Knürr Dacobas® System tables Technical data

Material / Finish

- Desk frame, sheet steel, zinc passivated
- Three layer particle board, FP/Y E1 version, fire protection class B 2
- Worktop covered with high pressure plastic laminate
- Desk legs, extruded aluminium, powder-coated texture
- Cover panels, three layer particle board, FP/Y E1 version, directly coated, fire protection class B2
- Drawer trims and drawer handles, plastic (PS)

Color

Final digit of order number .1:

- Worktop: light-grey (similar RAL 7035)
- Legs: RAL 5008, grey blue
- Cover panels, drawer trims and drawer handles: light-grey

Load rating

- Tested static surface load, 1500 N

Standards

- DIN 68761 for worktops
- EN 438 HGS class for high pressure plastic laminate

Note

- Please order socket strip separately

How supplied

- Knürr Dacobas® desks and combi desks are fully assembled
- Knürr Dacobas® add-on desks are supplied separately in modules



DAC20186

INFO

Please Note:

Further surface/color combination on request.

E.g.: Profiles RAL 7021 (dark grey) combined with maple or beech worktops.

Please ask for details!

SPACE MANAGEMENT MADE EASY!

Four basic modules enable room layouts for the most diverse applications:

A Knürr Dacobas® Combi Desk 19" Pedestal

B Knürr Dacobas® Trapezoid Corner

C Knürr Dacobas® Trapezoid Corner

C Knürr Dacobas® Combi Desk with Office Pedestal

D Knürr Dacobas® Superstructure

E Knürr Dacobas® Rear Panel

F Knürr Dacobas® Plexiglas Doors

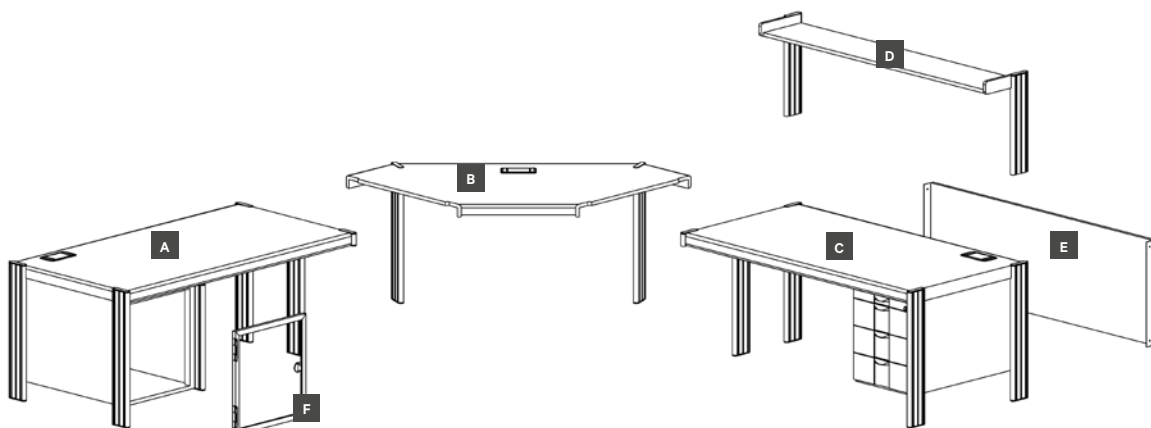

Knürr Dacobas®- End side panel

W	H	Order no.	UP
750		01.300.200.1	1 unit

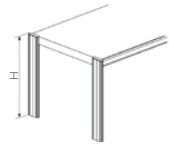

Knürr Dacobas®- Interlinking side panel

W	H	Order no.	UP
750		01.300.201.1	1 unit

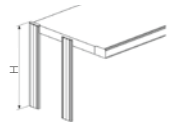

Knürr Dacobas®- Working level for add-on channel MD

*only in connection with add-on channel

W	D	Order no.	Order no. (ESD)	UP
630	670	01.300.210.1	01.300.230.1	1 unit
830	670	01.300.211.1	01.300.231.1	1 unit
1030	670	01.300.212.1	01.300.232.1	1 unit
1230	670	01.300.213.1	01.300.233.1	1 unit
1430	670	01.300.214.1	01.300.234.1	1 unit
1630	670	01.300.215.1	01.300.235.1	1 unit
1830	670	01.300.216.1	01.300.236.1	1 unit
2030	670	01.300.217.1	01.300.237.1	1 unit
630	870	01.300.220.1	01.300.240.1	1 unit
830	870	01.300.221.1	01.300.241.1	1 unit
1030	870	01.300.222.1	01.300.242.1	1 unit
1230	870	01.300.223.1	01.300.243.1	1 unit
1430	870	01.300.224.1	01.300.244.1	1 unit
1630	870	01.300.225.1	01.300.245.1	1 unit
1830	870	01.300.226.1	01.300.246.1	1 unit
2030	870	01.300.227.1	01.300.247.1	1 unit

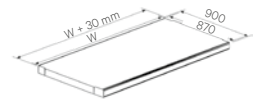

Knürr Dacobas®- Surface-mounted tray MD horizontal

W	H	D	Order no.	UP
630			01.300.280.1	1 unit
830			01.300.281.1	1 unit
1030			01.300.282.1	1 unit
1230			01.300.283.1	1 unit
1430			01.300.284.1	1 unit
1630			01.300.285.1	1 unit
1830			01.300.286.1	1 unit
2030			01.300.287.1	1 unit
570			01.300.290.1	1 unit
1140			01.300.291.1	1 unit
1710			01.300.292.1	1 unit
Shortened 19" rear panel for trunking 1x per 19" substructure (for W 570 / 1140 / 1710)				01.300.293.1 1 set



Dimensions in mm: W = Width
 H = Height
 D = Depth
 h = Installation height
 d = Useful depth
 L = Length

HU = Standard height unit, 1 HU = 44,45 mm
 19" = 482,6 mm.
 (ideal for 19" components in acc. with DIN 41494)
 UP = Unit of packaging

Conversion: 1 inch = 25,4 mm
 Replace „x“ with the number of your color choice

Knürr Dacobas®- 19" substructure

- 12U 19" substructure
- Removable side panels
- Rear panel with ventilation gills
- 4x 12U 19" T-slot profile

W	H	D (mm)	ET (mm)	Order no.	UP
19"	12 HU	670	566,5	01.321.095.1	1 Stk.
19"	12HU	870	766,5	01.321.097.1	1 Stk.

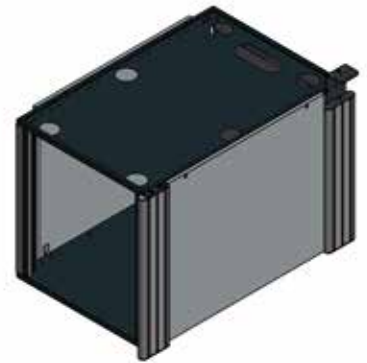

Knürr Dacobas®- Vertical duct

- Vertical cable duct for rear installation on the Dacobas profile
- With side brush strip for easy cable insertion
- Secure and concealed cable routing
- Top with E-set for wiring into the rear horizontal KV trunking
- **Color**
 - RAL 5008 grey blue

W	H	Order no.	UP
-	750	01.300.295.1	1 unit



Knürr Dacobas®- Shortened 19" rear panel for trunking + IM Profile

- 1x per 19" substructure (for W 570 / 1140 / 1710)

W	Order no.	UP
570 / 1140 / 1710	01.300.293.1	1 unit



Dimensions in mm: W = Width
 H = Height
 D = Depth
 h = Installation height
 d = Useful depth
 L = Length

HU = Standard height unit, 1 HU = 44.45 mm
 19" = 482.6 mm, (ideal for 19" components in acc. with DIN 41494)
 UP = Unit of packaging

Conversion: 1 inch = 25,4 mm
 Replace „x“ with the number of your color choice

• **Basic desk**

- Basic desk with 4 legs

• **Model**

- Without pedestal
- With lockable office pedestal, left or right
- Drawer height, 3 x 150 mm or 1 x 150 mm, 1 x 300 mm with suspension frame
- With 1 utility extension

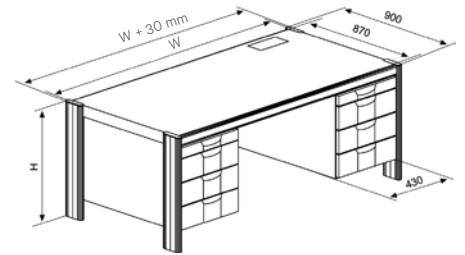

DAC00307

Knürr Dacobas® Desk
With / without office pedestal, depth 870 mm

W	H	D	CRS	ESD	Pedestal	Order no.	UP
1140	720	870	•		Without	01.300.100.1	1 unit
1710	720	870	•		Without	01.300.101.1	1 unit
570	750	870	•		Without	01.300.105.1	1 unit
1140	750	870	•		Without	01.300.102.1	1 unit
1710	750	870	•		Without	01.300.103.1	1 unit
570	720	870			Without	01.300.004.1	1 unit

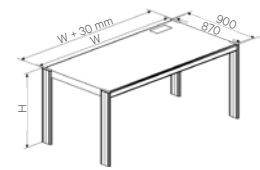

DAC20007

W	H	D	CRS	ESD	Pedestal	Order no.	UP
1140	720	870	•		3 x 150 mm, left	01.317.083.1	1 unit
1710	720	870	•		3 x 150 mm, left	01.317.055.1	1 unit
1140	750	870	•		3 x 150 mm, left	01.317.583.1	1 unit
1710	750	870	•		3 x 150 mm, left	01.317.555.1	1 unit
1140	750	870			3 x 150 mm, left	01.317.533.1	1 unit
1710	750	870			3 x 150 mm, left	01.317.505.1	1 unit
1140	750	870		•	3 x 150 mm, left	01.363.533.1	1 unit
1710	750	870		•	3 x 150 mm, left	01.363.505.1	1 unit

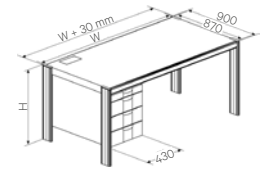

DAC20008

W	H	D	CRS	ESD	Pedestal	Order no.	UP
1140	720	870	•		3 x 150 mm, right	01.317.082.1	1 unit
1710	720	870	•		3 x 150 mm, right	01.317.056.1	1 unit
1140	750	870	•		3 x 150 mm, right	01.317.582.1	1 unit
1710	750	870	•		3 x 150 mm, right	01.317.556.1	1 unit
1140	750	870			3 x 150 mm, right	01.317.532.1	1 unit
1710	750	870			3 x 150 mm, right	01.317.506.1	1 unit
1140	750	870		•	3 x 150 mm, right	01.363.532.1	1 unit
1710	750	870		•	3 x 150 mm, right	01.363.506.1	1 unit

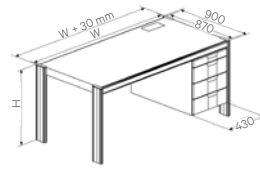

DAC20009

W	H	D	CRS	ESD	Pedestal	Order no.	UP
1140	720	870	•		150 + 300 mm, left	01.317.081.1	1 unit
1710	720	870	•		150 + 300 mm, left	01.317.058.1	1 unit
1140	750	870	•		150 + 300 mm, left	01.317.581.1	1 unit
1710	750	870	•		150 + 300 mm, left	01.317.558.1	1 unit
1140	750	870			150 + 300 mm, left	01.317.531.1	1 unit
1710	750	870			150 + 300 mm, left	01.317.508.1	1 unit
1140	750	870		•	150 + 300 mm, left	01.363.531.1	1 unit
1710	750	870		•	150 + 300 mm, left	01.363.508.1	1 unit

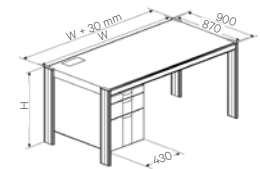

DAC20010

W	H	D	CRS	ESD	Pedestal	Order no.	UP
1140	720	870	•		150 + 300 mm, right	01.317.080.1	1 unit
1710	720	870	•		150 + 300 mm, right	01.317.059.1	1 unit
1140	750	870	•		150 + 300 mm, right	01.317.580.1	1 unit
1710	750	870	•		150 + 300 mm, right	01.317.559.1	1 unit
1140	750	870			150 + 300 mm, right	01.317.530.1	1 unit
1710	750	870			150 + 300 mm, right	01.317.509.1	1 unit
1140	750	870		•	150 + 300 mm, right	01.363.530.1	1 unit
1710	750	870		•	150 + 300 mm, right	01.363.509.1	1 unit

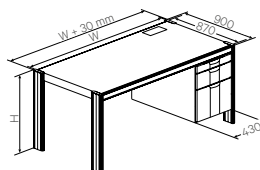

DAC20011

- **Basic desk**

- Basic desk with 4 legs

- **Model**

- With lockable office pedestal, left or right
- Drawer height, 3 x 150 mm or 1 x 150 mm, 1 x 300 mm with suspension frame
- With 1 utility extension

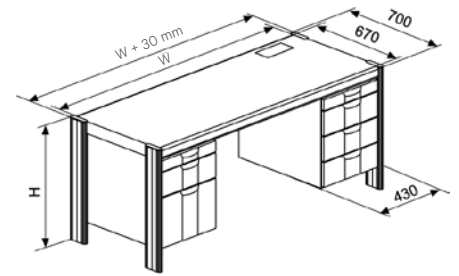

DAC00365

Knürr Dacobas® Desk With office pedestal, depth 670 mm

W	H	D	CRS	ESD	Pedestal	Order no.	UP
1140	720	670	•		3 x 150 mm, left	01.317.087.1	1 unit

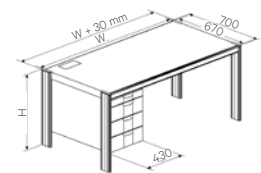

DAC20042

W	H	D	CRS	ESD	Pedestal	Order no.	UP
1140	720	670	•		3 x 150 mm, right	01.317.086.1	1 unit

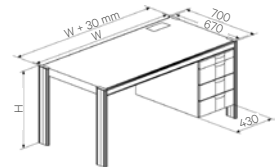

DAC20044

W	H	D	CRS	ESD	Pedestal	Order no.	UP
1140	720	670	•		150 + 300 mm, left	01.317.085.1	1 unit

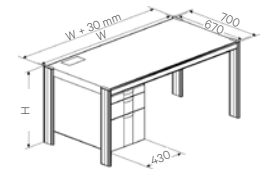

DAC20046

W	H	D	CRS	ESD	Pedestal	Order no.	UP
1140	720	670	•		150 + 300 mm, right	01.317.084.1	1 unit

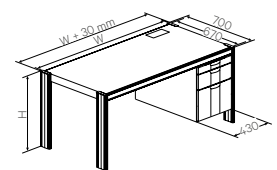

DAC20048

• **Basic desk**

- Basic desk with 4 legs

• **Model**

- Without pedestal
- With lockable office pedestal, left or right
- Drawer height, 3 x 150 mm or 1 x 150 mm, 1 x 300 mm with suspension frame
- With 1 utility extension

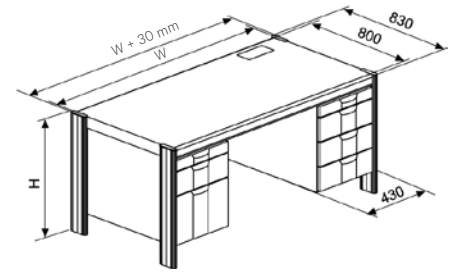

DAC00364

Knürr Dacobas® Desk
With / without office pedestal, depth 800 mm

W	H	D	CRS	Pedestal	Order no.	UP
1600	720	800		Without	01.311.081.1	1 unit

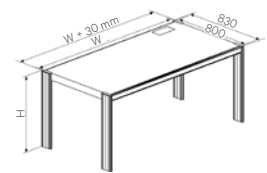

DAC20031

W	H	D	CRS	Pedestal	Order no.	UP
1200	720	800	•	3 x 150 mm, left	01.319.130.1	1 unit
1600	720	800	•	3 x 150 mm, left	01.319.115.1	1 unit

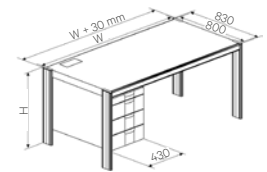

DAC20043

W	H	D	CRS	Pedestal	Order no.	UP
1200	720	800	•	3 x 150 mm, right	01.319.131.1	1 unit
1600	720	800	•	3 x 150 mm, right	01.319.116.1	1 unit

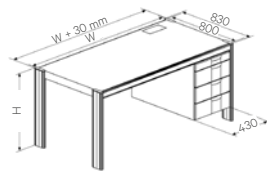

DAC20045

W	H	D	CRS	Pedestal	Order no.	UP
1200	720	800	•	150 + 300 mm, left	01.319.132.1	1 unit
1600	720	800	•	150 + 300 mm, left	01.319.117.1	1 unit

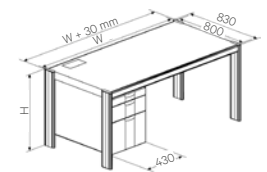

DAC20047

W	H	D	CRS	Pedestal	Order no.	UP
1200	720	800	•	150 + 300 mm, right	01.319.133.1	1 unit
1600	720	800	•	150 + 300 mm, right	01.319.118.1	1 unit

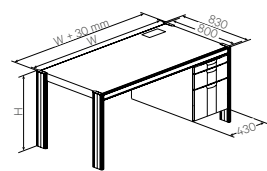

DAC20049

Dimensions in mm: W = Width
H = Height
D = Depth
h = Installation height
d = Useful depth
L = Length

HU = Standard height unit, 1 HU = 44,45 mm
19" = 482,6 mm, (ideal for 19" components in acc. with DIN 41494)
UP = Unit of packaging

Conversion: 1 inch = 25,4 mm
Replace „x“ with the number of your color choice

• Basic desk

- Basic desk with 4 legs
- 19" Pedestal, 536,6 mm in accordance with ICE 297
- Side panels removable
- Rear panel removable, with vent slots

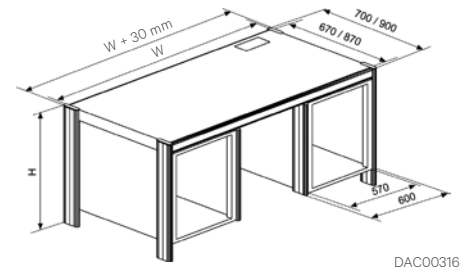

DAC00316

Knürr Dacobas® Desk With 19" office pedestal, depth 670 / 870 mm

W	H	D	CRS	Pedestal	Order no.	UP
570	750	670	•	Centre	01.304.108.1	1 unit
1140	750	670	•	Left	01.304.106.1	1 unit
1710	750	670	•	Left	01.304.110.1	1 unit

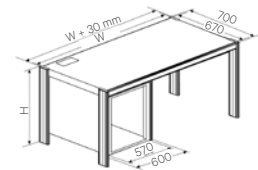

DAC20012

W	H	D	CRS	Pedestal	Order no.	UP
570	750	870	•	Centre	01.304.105.1	1 unit
1140	750	870	•	Left	01.304.103.1	1 unit
1710	750	870	•	Left	01.304.101.1	1 unit

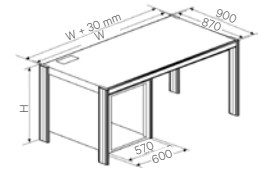

DAC20033

W	H	D	CRS	Pedestal	Order no.	UP
1140	750	670	•	Right	01.304.107.1	1 unit
1710	750	670	•	Right	01.304.111.1	1 unit

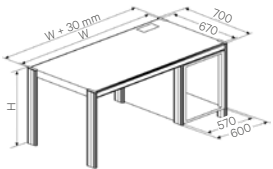

DAC20034

W	H	D	CRS	Pedestal	Order no.	UP
1140	750	870	•	Right	01.304.104.1	1 unit
1710	750	870	•	Right	01.304.102.1	1 unit

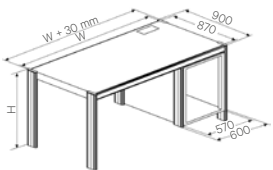

DAC20013

W	H	D	CRS	Pedestal	Order no.	UP
1710	750	670	•	Left + right	01.304.109.1	1 unit

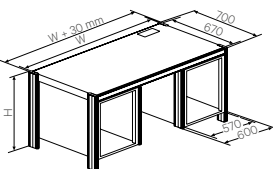

DAC20014

W	H	D	CRS	Pedestal	Order no.	UP
1710	750	870	•	Left + right	01.304.100.1	1 unit

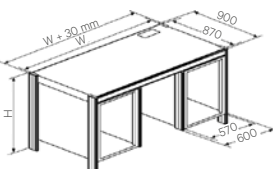

DAC20066

• **Combi desk**

- Combi desk with 4 legs and link-up extrusion
- Offset leg to ensure unobstructed leg space

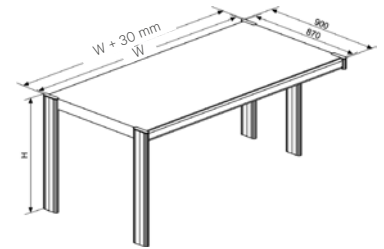

DAC20015

Knürr Dacobas® Combi Desk*
 Without office pedestal, depth 870 mm

W	H	D	CRS	ESD	Pedestal/Link-up	Order no.	UP
570	750	870	•		Without, left	01.300.343.1	1 unit
1140	750	870	•		Without, left	01.300.345.1	1 unit
1710	750	870	•		Without, left	01.300.347.1	1 unit

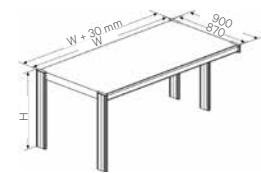

DAC20015

W	H	D	CRS	ESD	Pedestal/Link-up	Order no.	UP
570	750	870	•		Without, right	01.300.344.1	1 unit
1140	750	870	•		Without, right	01.300.346.1	1 unit
1710	750	870	•		Without, right	01.300.348.1	1 unit



DAC20148

W	H	D	CRS	ESD	Pedestal/Link-up	Order no.	UP
570	750	870			Without, left	01.300.331.1	1 unit
1140	750	870			Without, left	01.300.333.1	1 unit
1710	750	870			Without, left	01.300.335.1	1 unit
570	750	870		•	Without, left	01.360.331.1	1 unit
1140	750	870		•	Without, left	01.360.333.1	1 unit
1710	750	870		•	Without, left	01.360.335.1	1 unit

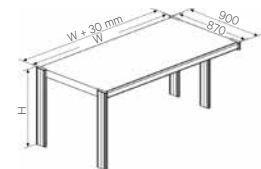

DAC20015

W	H	D	CRS	ESD	Pedestal/Link-up	Order no.	UP
570	750	870			Without, right	01.300.332.1	1 unit
1140	750	870			Without, right	01.300.334.1	1 unit
1710	750	870			Without, right	01.300.336.1	1 unit
570	750	870	•		Without, right	01.360.332.1	1 unit
1140	750	870	•		Without, right	01.360.334.1	1 unit
1710	750	870	•		Without, right	01.360.336.1	1 unit



DAC20148

* Combi desk:
 with offset extrusion in the combi range

Dimensions in mm: W = Width
 H = Height
 D = Depth
 h = Installation height
 d = Useful depth
 L = Length
 HU = Standard height unit, 1 HU = 44.45 mm
 19" = 482.6 mm.
 (ideal for 19" components in acc. with DIN 41494)
 UP = Unit of packaging

Conversion: 1 inch = 25.4 mm
 Replace „x“ with the number of your color choice

• Combi desk

- Combi desk with 4 legs and link-up extrusion
- Offset leg to ensure unobstructed leg space
- With lockable office pedestal

• Model

- With office pedestal
- Drawer height, 3 x 150 mm or 1 x 150 mm, 1 x 300 mm with suspension frame
- With 1 utility extension

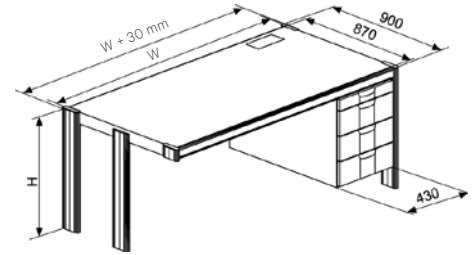

DAC00320

Knürr Dacobas® Combi Desk* With office pedestal, depth 870 mm

W	H	D	CRS	ESD	Pedestal/Link-up	Order no.	UP
1140	720	870	•		3 x 150 mm, left	01.317.341.1	1 unit
1710	720	870	•		3 x 150 mm, left	01.317.345.1	1 unit
1140	750	870	•		3 x 150 mm, left	01.317.841.1	1 unit
1710	750	870	•		3 x 150 mm, left	01.317.845.1	1 unit
1140	750	870			3 x 150 mm, left	01.317.825.1	1 unit
1710	750	870			3 x 150 mm, left	01.317.829.1	1 unit
1140	750	870		•	3 x 150 mm, left	01.363.825.1	1 unit
1710	750	870		•	3 x 150 mm, left	01.363.829.1	1 unit

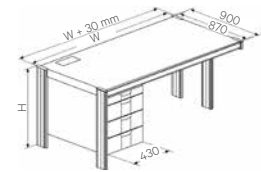

DAC20051

W	H	D	CRS	ESD	Pedestal/Link-up	Order no.	UP
1140	720	870	•		3 x 150 mm, right	01.317.340.1	1 unit
1710	720	870	•		3 x 150 mm, right	01.317.344.1	1 unit
1140	750	870	•		3 x 150 mm, right	01.317.840.1	1 unit
1710	750	870	•		3 x 150 mm, right	01.317.844.1	1 unit
1140	750	870			3 x 150 mm, right	01.317.824.1	1 unit
1710	750	870			3 x 150 mm, right	01.317.828.1	1 unit
1140	750	870		•	3 x 150 mm, right	01.363.824.1	1 unit
1710	750	870		•	3 x 150 mm, right	01.363.828.1	1 unit

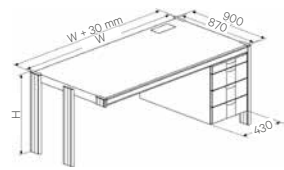

DAC20053

W	H	D	CRS	ESD	Pedestal/Link-up	Order no.	UP
1140	720	870	•		150 + 300 mm, left	01.317.343.1	1 unit
1710	720	870	•		150 + 300 mm, left	01.317.347.1	1 unit
1140	750	870	•		150 + 300 mm, left	01.317.843.1	1 unit
1710	750	870	•		150 + 300 mm, left	01.317.847.1	1 unit
1140	750	870			150 + 300 mm, left	01.317.827.1	1 unit
1710	750	870			150 + 300 mm, left	01.317.831.1	1 unit
1140	750	870		•	150 + 300 mm, left	01.363.827.1	1 unit
1710	750	870		•	150 + 300 mm, left	01.363.831.1	1 unit

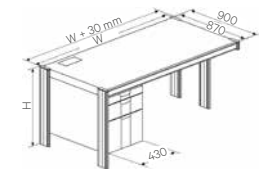

DAC20055

W	H	D	CRS	ESD	Pedestal/Link-up	Order no.	UP
1140	720	870	•		150 + 300 mm, right	01.317.342.1	1 unit
1710	720	870	•		150 + 300 mm, right	01.317.346.1	1 unit
1140	750	870	•		150 + 300 mm, right	01.317.842.1	1 unit
1710	750	870	•		150 + 300 mm, right	01.317.846.1	1 unit
1140	750	870			150 + 300 mm, right	01.317.826.1	1 unit
1710	750	870			150 + 300 mm, right	01.317.830.1	1 unit
1140	750	870		•	150 + 300 mm, right	01.363.826.1	1 unit
1710	750	870		•	150 + 300 mm, right	01.363.830.1	1 unit

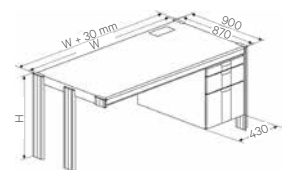

DAC20057

* Combi desk:
with offset extrusion in the combi range

• **Combi desk**

- Combi desk with 4 legs and link-up extrusion
- Offset leg to ensure unobstructed leg space
- With or without lockable office pedestal

• **Model**

- With office pedestal
- Drawer height, 3 x 150 mm or 1 x 150 mm, 1 x 300 mm with suspension frame
- With 1 utility extension

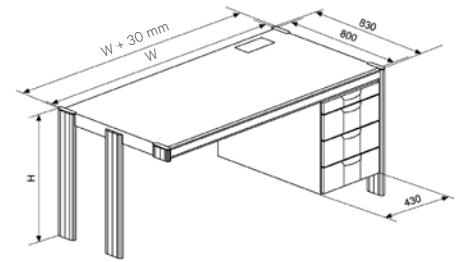

DAC00328

Knürr Dacobas® Combi Desk*
 With office pedestal, depth 800 mm

W	H	D	CRS	Pedestal / For linking	Order no.	UP
1200	720	800	•	3 x 150 mm, left	01.319.150.1	1 unit
1600	720	800	•	3 x 150 mm, left	01.319.145.1	1 unit

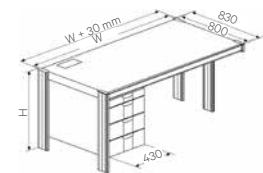

DAC20017

W	H	D	CRS	Pedestal / For linking	Order no.	UP
1200	720	800	•	3 x 150 mm, right	01.319.151.1	1 unit
1600	720	800	•	3 x 150 mm, right	01.319.146.1	1 unit

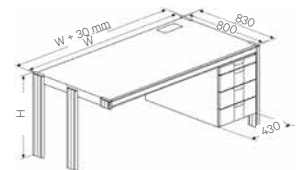

DAC20018

W	H	D	CRS	Pedestal / For linking	Order no.	UP
1200	720	800	•	150 + 300 mm, left	01.319.152.1	1 unit
1600	720	800	•	150 + 300 mm, left	01.319.147.1	1 unit

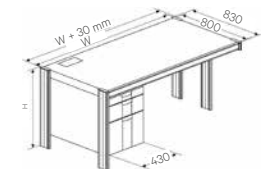

DAC20019

W	H	D	CRS	Pedestal / For linking	Order no.	UP
1200	720	800	•	150 + 300 mm, right	01.319.153.1	1 unit
1600	720	800	•	150 + 300 mm, right	01.319.148.1	1 unit

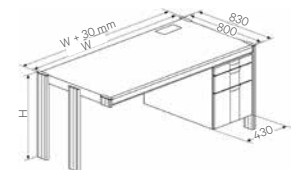

DAC20020

* Combi desk:
 with offset extrusion in the combi range

Dimensions in mm: W = Width
 H = Height
 D = Depth
 h = Installation height
 d = Useful depth
 L = Length
 HU = Standard height unit, 1 HU = 44.45 mm
 19" = 482.6 mm.
 (ideal for 19" components in acc. with DIN 41494)
 UP = Unit of packaging

Conversion: 1 inch = 25.4 mm
 Replace „x“ with the number of your color choice

• Combi desk

- Combi desk with 4 legs and link-up extrusion
- Offset leg to ensure unobstructed leg space
- With 19" pedestal, 536,6 mm in accordance with ICE 297
- Side panels removable
- Rear panel removable, with vent slots
- 1 HU = 44.45 mm

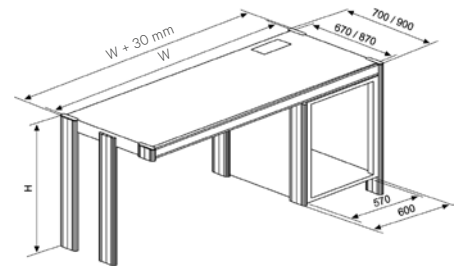

DAC00330

Knürr Dacobas® Combi Desk* With 19" office pedestal, depth 870 mm

W	H	D	CRS	Pedestal / For linking	Order no.	UP
1140	750	870	•	Left	01.304.315.1	1 unit
1710	750	870	•	Left	01.304.317.1	1 unit

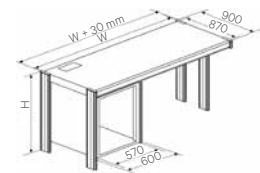

DAC20021

W	H	D	CRS	Pedestal / For linking	Order no.	UP
1140	750	870	•	Right	01.304.314.1	1 unit
1710	750	870	•	Right	01.304.316.1	1 unit

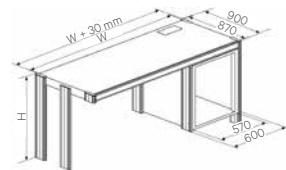

DAC20140

* Combi desk:
with offset extrusion in the combi range

Dimensions in mm: W = Width
H = Height
D = Depth
h = Installation height
d = Useful depth
L = Length
HU = Standard height unit, 1 HU = 44.45 mm
19" = 482.6 mm.
(ideal for 19" components in acc. with DIN 41494)
UP = Unit of packaging

Conversion: 1 inch = 25.4 mm
Replace „x“ with the number of your color choice

• **Add-on desk**

- Add-on desk with 2 legs
- With or without lockable office pedestal

• **Model**

- Without office pedestal
- With office pedestal
- Drawer height, 3 x 150 mm or 1 x 150 mm, 1 x 300 mm with suspension frame
- With 1 utility extension

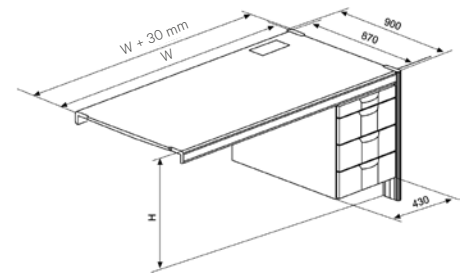

DAC00333

Knürr Dacobas® Add-On Desk*
With / without office pedestal, depth 870 mm

W	H	D	CRS	ESD	Pedestal / For add-on	Order no.	UP
570	750	870			Without, left or right	01.300.359.1	1 unit
1140	750	870			Without, left or right	01.300.360.1	1 unit
1710	750	870			Without, left or right	01.300.361.1	1 unit
570	750	870		•	Without, left or right	01.360.359.1	1 unit
1140	750	870		•	Without, left or right	01.360.360.1	1 unit
1710	750	870		•	Without, left or right	01.360.361.1	1 unit

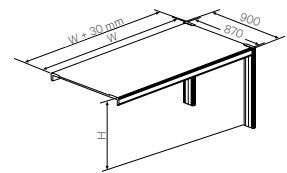

DAC20141

W	H	D	CRS	ESD	Pedestal / For add-on	Order no.	UP
1140	720	870	•		3 x 150 mm, left	01.317.375.1	1 unit
1710	720	870	•		3 x 150 mm, left	01.317.379.1	1 unit
1140	750	870	•		3 x 150 mm, left	01.317.875.1	1 unit
1710	750	870	•		3 x 150 mm, left	01.317.879.1	1 unit
1140	750	870			3 x 150 mm, left	01.317.859.1	1 unit
1710	750	870			3 x 150 mm, left	01.317.863.1	1 unit

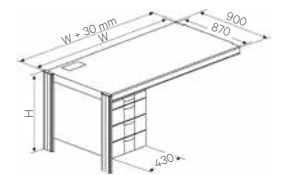

DAC20142

W	H	D	CRS	ESD	Pedestal / For add-on	Order no.	UP
1140	720	870	•		3 x 150 mm, right	01.317.374.1	1 unit
1710	720	870	•		3 x 150 mm, right	01.317.378.1	1 unit
1140	750	870	•		3 x 150 mm, right	01.317.874.1	1 unit
1710	750	870	•		3 x 150 mm, right	01.317.878.1	1 unit
1140	750	870			3 x 150 mm, right	01.317.858.1	1 unit
1710	750	870			3 x 150 mm, right	01.317.862.1	1 unit

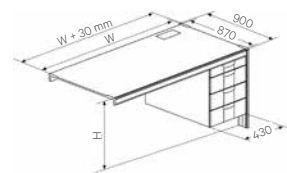

DAC20143

W	H	D	CRS	ESD	Pedestal / For add-on	Order no.	UP
1140	720	870	•		150 + 300 mm, left	01.317.377.1	1 unit
1710	720	870	•		150 + 300 mm, left	01.317.381.1	1 unit
1140	750	870	•		150 + 300 mm, left	01.317.877.1	1 unit
1710	750	870	•		150 + 300 mm, left	01.317.881.1	1 unit
1140	750	870			150 + 300 mm, left	01.317.861.1	1 unit
1710	750	870			150 + 300 mm, left	01.317.865.1	1 unit

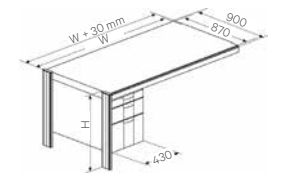

DAC20144

W	H	D	CRS	ESD	Pedestal / For add-on	Order no.	UP
1140	720	870	•		150 + 300 mm, right	01.317.376.1	1 unit
1710	720	870	•		150 + 300 mm, right	01.317.380.1	1 unit
1140	750	870	•		150 + 300 mm, right	01.317.876.1	1 unit
1710	750	870	•		150 + 300 mm, right	01.317.880.1	1 unit
1140	750	870			150 + 300 mm, right	01.317.860.1	1 unit
1710	750	870			150 + 300 mm, right	01.317.864.1	1 unit
1710	750	870		•	150 + 300 mm, right	01.363.864.1	1 unit

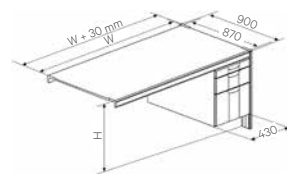

DAC20145

- **Add-on desk**

- Add-on desk, with 2 legs
- With or without lockable office pedestal

- **Model**

- With office pedestal
- Drawer height, 3 x 150 mm or 1 x 150 mm, 1 x 300 mm with suspension frame
- With 1 utility extension

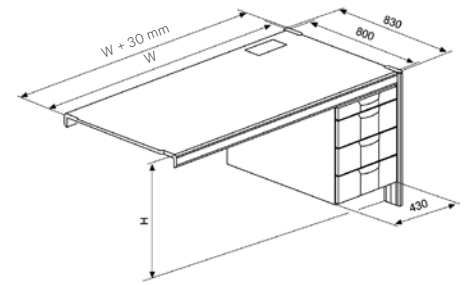

DAC00361

Knürr Dacobas® Add-On Desk* With office pedestal, depth 800 mm

W	H	D	CRS	Pedestal / For add-on	Order no.	UP
1200	720	800	•	3 x 150 mm, left	01.319.175.1	1 unit
1600	720	800	•	3 x 150 mm, left	01.319.170.1	1 unit

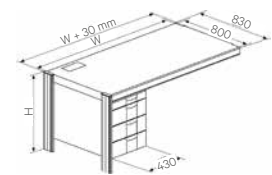

DAC20059

W	H	D	CRS	Pedestal / For add-on	Order no.	UP
1200	720	800	•	3 x 150 mm, right	01.319.176.1	1 unit
1600	720	800	•	3 x 150 mm, right	01.319.171.1	1 unit

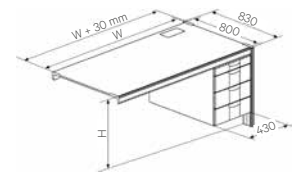

DAC20061

W	H	D	CRS	Pedestal / For add-on	Order no.	UP
1200	720	800	•	150 + 300 mm, left	01.319.177.1	1 unit
1600	720	800	•	150 + 300 mm, left	01.319.172.1	1 unit

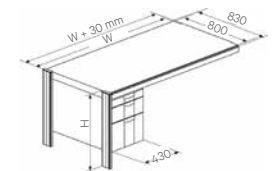

DAC20063

W	H	D	CRS	Pedestal / For add-on	Order no.	UP
1200	720	800	•	150 + 300 mm, right	01.319.178.1	1 unit
1600	720	800	•	150 + 300 mm, right	01.319.173.1	1 unit

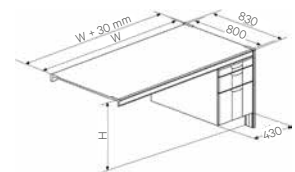

DAC20065

* Add-on desk:
Without extrusions in the link-up range

Dimensions in mm: W = Width
H = Height
D = Depth
h = Installation height
d = Useful depth
L = Length
HU = Standard height unit, 1 HU = 44.45 mm
19" = 482.6 mm, (ideal for 19" components in acc. with DIN 41494)
UP = Unit of packaging

Conversion: 1 inch = 25.4 mm
Replace „x“ with the number of your color choice

• **Add-on desk**

- Add-on desk with 2 legs
- With or without 19" pedestal, 536,6 mm in accordance with ICE 297
- Side panels removable
- Rear panel removable, with vent slots

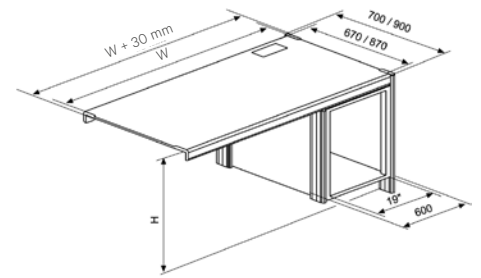

DAC00366

Knürr Dacobas® Add-On Desk*

With / without 19" office pedestal, depth 670 / 870 mm

W	H	D	CRS	Pedestal / For add-on	Order no.	UP
570	750	870	•	Without, left or right	01.300.377.1	1 unit
1140	750	870	•	Without, left or right	01.300.378.1	1 unit
1710	750	870	•	Without, left or right	01.300.380.1	1 unit

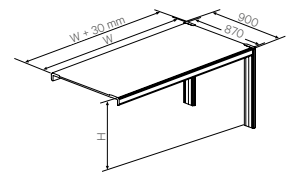

DAC20141

W	H	D	CRS	Pedestal / For add-on	Order no.	UP
1140	750	870	•	Left	01.304.335.1	1 unit
1710	750	870	•	Left	01.304.337.1	1 unit

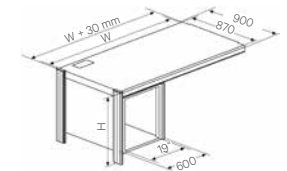

DAC20146

W	H	D	CRS	Pedestal / For add-on	Order no.	UP
1140	750	870	•	Right	01.304.334.1	1 unit
1710	750	870	•	Right	01.304.336.1	1 unit

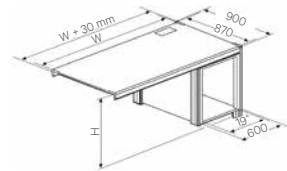

DAC20147

INFO

Recommended Accessoires:

- Corner Pieces p.144/145
- Rear Panels p.147

19" Desk Pedestal

	Variant I	Variant II
Rack depth / enclosure depth D (mm)	670 / 870	670 / 870
Chassis depth d (mm)	566,5 / 766,5	518 / 718

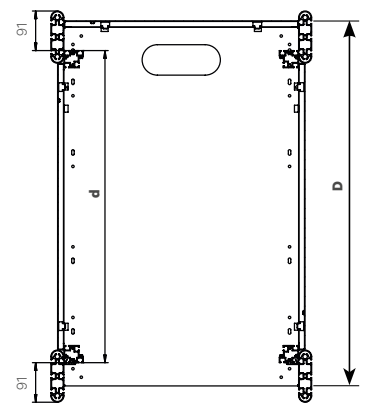
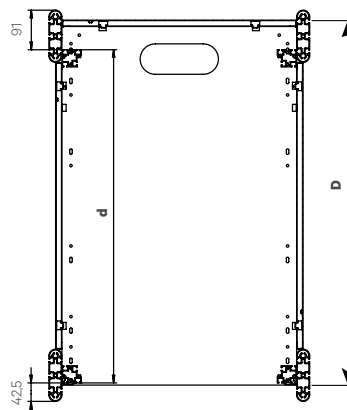

- **Mobile PC workstation with 4 legs**
- **Model**
 - With lockable office pedestal, left or right
 - Drawer height 1 x 150 mm, 1 x 300 mm with suspension frame
 - With utility extension
 - Removable desk extension, 200 mm
 - Second working level, load rating 300 N, static surface load
 - With foot frame
 - With 2x fixed and 2x swivel castors

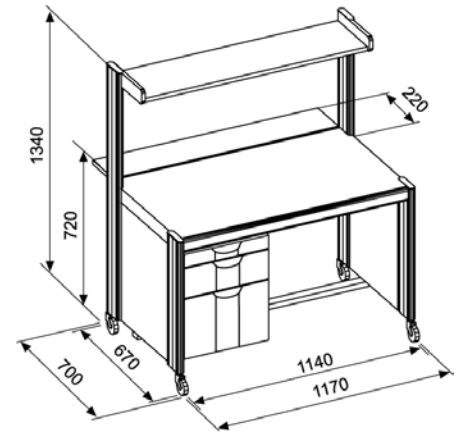

DAC00342

Knürr Dacobas® Mobile PC Workstation

W	H	D	CRS	EDS	Pedestal	Order no.	UP
1140	720 / 1340	670			Left	01.317.040.1	1 unit

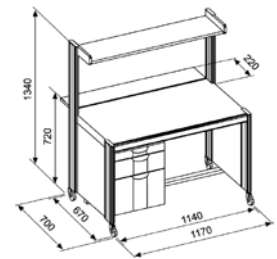

DAC00342

W	H	D	CRS	EDS	Pedestal	Order no.	UP
1140	720 / 1340	670			Right	01.317.041.1	1 unit

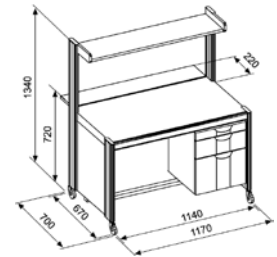

DAC20078

Knürr Dacobas® Triangle Corner, 90° With corner frame and mounting material

- 90° Triangle corner with corner frame and mounting material

A	B	Order no.	UP
870	870	01.300.050.1	1 unit

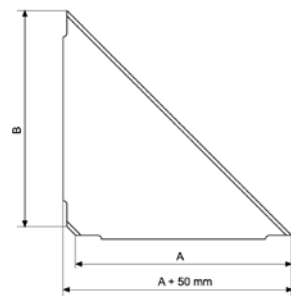

DAC00499

Knürr Dacobas® Triangle Corner, 60° With corner frame and mounting material

- 60° Triangle corner with corner frame and mounting material

A	B	Order no.	UP
870	870	01.300.059.1	1 unit

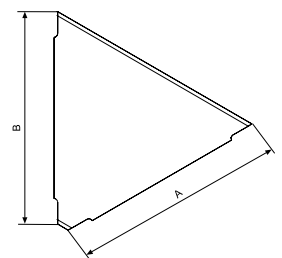

DAC00372

Dimensions in mm: W = Width
H = Height
D = Depth
h = Installation height
d = Useful depth
L = Length

HU = Standard height unit, 1 HU = 44,45 mm
19" = 482,6 mm,
(ideal for 19" components in acc. with DIN 41494)
UP = Unit of packaging

Conversion: 1 inch = 25,4 mm
Replace „x“ with the number of your color choice

Knürr Dacobas® Triangle Corner, 45° With corner frame and mounting material

- 45° Triangle corner with corner frame and mounting material

A	B	ESD	Order no.	UP
870	870		01.300.045.1	1 unit
870	870	•	01.360.045.1	1 unit

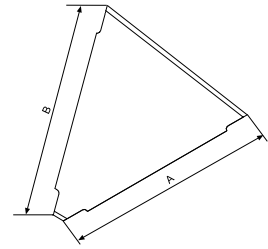

DAC2017

Knürr Dacobas® Wall Corner With corner frame, desk leg and mounting material

- Wall corner with corner frame, desk leg and mounting material

H	A	B	ESD	Order no.	UP
720	870	870		01.300.031.1	1 unit
720	670	870		01.300.033.1	1 unit
720	870	670		01.300.032.1	1 unit
720	670	670		01.300.030.1	1 unit
750	870	870	•	01.360.035.1	1 unit

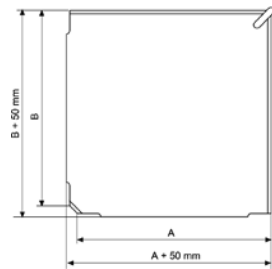

DAC00374

Knürr Dacobas® Trapezoid Corner With corner frame, desk leg and mounting material

- Trapezoid corner with corner frame, 2 desk legs and mounting material

H	A	B	C	D	CRS	ESD	Order no.	UP
720	870	610	1317	870	•		01.300.137.1	1 unit
750	870	610	1317	870	•		01.300.141.1	1 unit
750	670	610	1117	729	•		01.300.143.1	1 unit
750	870	610	1317	870	•		01.360.140.1	1 unit

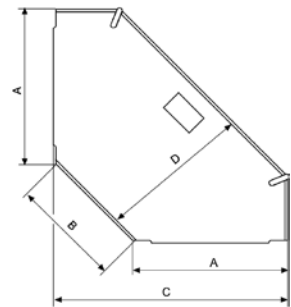

DAC00496

Knürr Dacobas® Trapezoid Wall Corner With corner frame, desk leg and mounting material

- Trapezoid wall corner with corner frame, 1 desk leg and mounting material

H	A	B	C	CRS	Order no.	UP
720	870	610	1317	•	01.300.123.1	1 unit
750	870	610	1317	•	01.300.127.1	1 unit

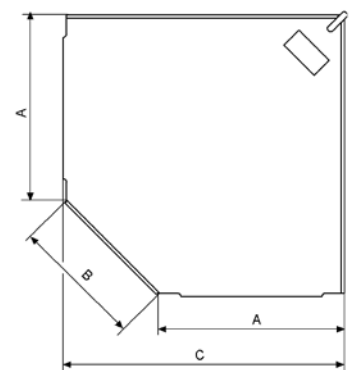

DAC00495

Knürr Dacobas® Extrusion

- Aluminium extrusion with 3 T-slots on each side
- For extrusion extension
- For mounting vertical cable duct, lights, Rapomos®, mini distributors, flat screens and functional rails
- **Material / Finish**
 - Extrusion: extruded aluminium, powder-coated texture
- **Color**
 - Extrusions: RAL 5008, grey-blue
 - Caps: RAL 5008 grey-blue and RAL 9011, graphite black (for ESD)
- **Supply schedule**
 - 2 extrusions
 - 1 mounting instructions
 - Mounting material
- **How supplied**
 - Single unit

L	Order no.	UP
450	01.321.105.1	1 pair
890	01.321.106.1	1 pair
830	01.321.107.1	1 pair



EAP20007

Storage Tray Tilt adjustable

- To set down instruments and organisational material
- Ergonomic positioning with tilt adjustment of +/- 5°
- Mounting between the Knürr Dacobas® extrusions
- Height adjustable on the vertical Knürr Dacobas® extrusions
- Also for mounting above the underfit lamp
- **Material / Finish**
 - Storage tray: sheet steel, antistatic powder-coated texture, RAL 7035 light-grey
- **Supply schedule**
 - 1 storage tray
 - Mounting material
- **Note**
 - From width 1630 mm with additional strength
- **Load rating**
 - 750 N (static surface load)

W	H	D	Model	Order no.	UP
830	400		Knürr Dacobas®	01.321.320.1	1 unit
1030	400		Knürr Dacobas®	01.321.321.1	1 unit
1230	400		Knürr Dacobas®	01.321.322.1	1 unit
1430	400		Knürr Dacobas®	01.321.323.1	1 unit
1630	400		Knürr Dacobas®	01.321.324.1	1 unit
1830	400		Knürr Dacobas®	01.321.325.1	1 unit
2030	400		Knürr Dacobas®	01.321.326.1	1 unit



EAP20023

Dimensions in mm: W = Width
H = Height
D = Depth
h = Installation height
d = Useful depth
L = Length

OU = Office unit (50 mm)
HU = Standard height unit, 1 HU = 44.45 mm
19" = 482.6 mm.
(ideal for 19" components in acc. with DIN 41494)
UP = Unit of packaging

Conversion: 1 inch = 25.4 mm
Replace „x“ with the number of your color choice

Knürr Dacobas® Desk Rear Panel

- Modesty panel
- For Knürr Dacobas® desks with and without 19" pedestals or with and without office pedestals
- **Standards**
 - DIN 68761 for cover
- **Material / Finish**
 - Mounting bracket, sheet steel, powder-coated texture
 - Cover: three layer particle board, FP / Y E1 version, fire protection class B2

- **Color**
 - **Retaining extrusions:**
 - RAL 9011 graphite black
 - Wooden parts: light-grey
- **Supply schedule**
 - 2 Mounting brackets
 - 1 Rear panel
 - Mounting material
- **How supplied**
 - Flat packed in modules



EAP20020

W	H	D	Order no.	UP
540	580	570	01.301.555.1	1 unit
1110	580	1140	01.301.556.1	1 unit
1680	580	1710	01.301.557.1	1 unit

Knürr Dacobas® Desk Side Panels with Retaining Extrusions For desk height, 750 mm

W	H	D	Order no.	UP
	580	670	01.302.419.1	1 unit
	580	870	01.302.417.1	1 unit



EAP20019

Knürr Dacobas® Leg Set for Add-on Desks For connecting 3-way desk combinations

- **Material / Finish**
 - Desk leg, extruded aluminium, powder-coated texture
- **Color**
 - RAL 5008, grey blue
- **Supply schedule**
 - 1 Desk leg, L 695 mm with levelling screw and caps
 - 1 Link-up extrusion, L 67 mm with caps
- **How supplied**
 - Flat-packed kit

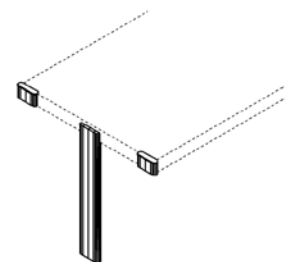

DAC00356

W	H	D	Order no.	UP
	720		01.300.078.1	1 unit
	750		01.300.079.1	1 unit

Knürr Dacobas® Computer Mounting Bracket

- Can be mounted left, right or both sides on the vertical extrusion at any height
- Width adjustable from 165 mm to 265 mm
- **Material / Finish**
 - Sheet steel, conductive powder-coated texture, RAL 7035 light-grey
- **Load rating**
 - 250 N (static surface load)
- **Note**
 - The lowest mounting position should be 80 mm (min. floor clearance)
- **Supply schedule**
 - 1 computer support
 - Mounting material
- **How supplied**
 - Flat-packed kit

W	H	D	Order no.	UP
165 - 265	319	463	04.208.078.1	1 unit



EAP20025

Knürr Dacobas® PC Pedestal, sheet steel model

- **PC Pedestal**
 - PC pedestal with front and rear door, lockable
 - With extension and master switch
 - With cable entry
- **Dimensions**
 - **Useful space with extension:**
 - Width = 300 mm, height = 542 mm
 - Without extension: Width = 300 mm, height = 590 mm
- **For mounting on Knürr Dacobas® add-on desks***

D	Pedestal	Order no.	UP
870	Left	01.302.218.1	1 unit
800	Left	01.311.308.1	1 unit
870	Right	01.302.219.1	1 unit
800	Right	01.311.309.1	1 unit

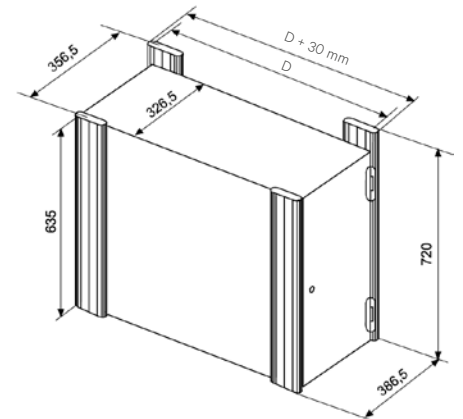

DAC00341

Knürr Dacobas® PC Pedestal

- Bonded main unit
- With passive ventilation *
- Full glass doors and lock at the front
- Stationary with leveling feet
- With cable routing set at the rear top for cabling in the vertical cable duct
- **Color combination**
 - **Final digit of order number .1:**
 - Main unit: Light gray
 - Door: Full glass door, EMC, 6 mm, clear glass
- **Material / finish**
 - Main unit: Three layer particle board FP/Y E 1 version, directly coated, fire protection class B2
 - Front doors: Full glass doors, EMC, 6 mm, clear glass
- **Supply schedule**
 - 1 PC pedestal
 - Mounting material
- **How supplied**
 - Preassembled

W	H	D	w	h	d	Model	Order no.	UP
350	680	826	310	630	780	Mounting left, Lock for H 750, right	00.320.540.1	1 unit
350	680	826	310	630	780	Mounting right, Lock for H 750, left	00.320.541.1	1 unit
350	650	826	310	600	780	Mounting left, Lock for H 720, right	00.320.542.1	1 unit
350	650	826	310	600	780	Mounting right, Lock for H 720, left	00.320.543.1	1 unit



DAC20183

SMALL ELECTRONIC DISTRIBUTORS

149 to 160



Small electronic distributors Strong points

1 The Electronics Mini Distributor Rack extends the basic desk (Knürr Dacobas® and Knürr Elicon®) with additional installation options of electronic components up to 91 mm installation depth in the horizontal pitch raster.

2 Design
The Electronics Mini Distributor Rack is based on an innovative extruded aluminium extrusion. T-slots and screw-in-slots are used for fixing trade standard installation technology. The mini distributor can be fitted at the front with front panel sections. With the side adapter, the mini distributor can be mounted on the Dacobas® and Elicon® workstation systems.

3 Flexibility
Flexible use of the most varied electrical components in screw-in-slots provided for this purpose.

4 Electrical safety
With the antistatic powder-coated aluminium extrusion all discharge processes take place controlled. Electrical safety with front panels earthed with earthing spring strips. Separation of data and power carrying cables with cable separator.

- **Reduced installation time**
 - Pre-wiring of electrical components through to complex complete wiring.
 - Innovative plug technology reduces the 4-way bolting to 2 screw connections per horizontal pitch.



1 EAP20016



3 EAP20076



4 EAP20039

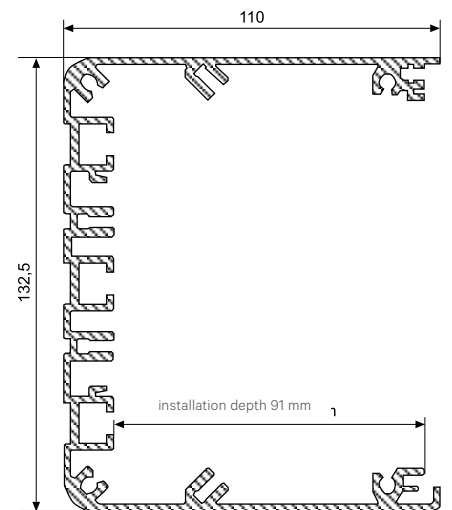

2 RAP00133

Dimensions in mm: W = Width
H = Height
D = Depth
h = Installation height
d = Useful depth
L = Length

HU = Standard height unit, 1 HU = 44.45 mm
HP = Horizontal pitch
OU = Office unit
19" = 482.6 mm, (ideal for 19" components in acc. with DIN 41494)
UP = Unit of packaging

Conversion: 1 inch = 25.4 mm

Replace „x“ with the number of your color choice

Mini Distributor For Knürr Dacobas® System tables

- Extruded aluminium mini distributor, powder-coated, antistatic texture
- T-slots and screw channels are used to mount trade standard installation technology.
- Front mounting of standardised 3 HU front panel sections
- Side adapter for mounting on the Knürr Dacobas® Electronic Workstation

Material / Finish

- Extruded aluminium, antistatic powder-coated texture, RAL 7035, light-grey
- Adapter: sheet steel, antistatic powder-coated texture, RAL 7035, light-grey

Attention!

- To ensure protection against electric shock, empty sections must be covered with front panel sections.

Supply schedule

- 1 mini distributor
- 2 mounting adapters
- 1 mounting instructions
- Mounting material

W	HP	Order no.	UP
830	147	01.321.152.1	1 unit
1030	189	01.321.153.1	1 unit
1230	231	01.321.154.1	1 unit
1430	266	01.321.155.1	1 unit
1630	308	01.321.156.1	1 unit
1830	350	01.321.157.1	1 unit
2030	385	01.321.158.1	1 unit



EAP20013

Mini Distributor For Knürr Elicon® Classic workstations

- Extruded aluminium mini distributor, powder-coated, antistatic texture
- T-slots and screw channels are used to mount trade standard installation technology
- Front mounting of standardised 3 HU front panel sections
- Side adapter for mounting on the Knürr Elicon® workstation system

Material / Finish

Final digit of order number .1

- Extruded aluminium, antistatic powder-coated texture, RAL 7035, light-grey
- Adapter: sheet steel, antistatic powder-coated texture, RAL 7035, light-grey

Attention!

- To ensure protection against electric shock, empty sections must be covered with front panel sections.

Supply schedule

- 1 mini distributor
- 2 mounting adapters
- 1 mounting instructions
- Mounting material

W	HP	Order no.	UP
800	147	04.211.000.1	1 unit
1200	224	04.211.001.1	1 unit
1600	301	04.211.002.1	1 unit
1800	343	04.211.003.1	1 unit
2000	378	04.211.004.1	1 unit



EAP20013

Safety Mains Supply, 230V or 400V

- Combi ON-OFF switch with integrated signal light
 - Optimal user protection with fault current circuit breaker and emergency STOP switch
 - By activating the emergency STOP switch, all devices in the superstructure are turned off
 - In addition to this workstation emergency STOP function, a floating break contact for looping into a room emergency STOP function is also provided.
- Technical data**
- Input voltage**
- 230 VAC, ± 10%, max. 16A with 230V version, 400 VAC, ± 10%, max. 16A with 400V version
- Switch**
- Combi ON-OFF switch with integrated signal light
- Emergency STOP**
- Workstation emergency STOP built in
 - Room emergency STOP prepared
- Room emergency STOP**
- Floating break contact, switching capacity 230 VAC/6A
- RCCB safety switch**
- Nom. current 25A, fault current 30 mA
- Mains supply safety switch**
- With 230 V: 2-pole nom. current, 16 A with 400 V: 3 pole nom. current 16 A Trip characteristic type C
- Material / Finish**
- Front panel: aluminium plate, 2.5 mm, painted RAL 7035 light-grey, smooth

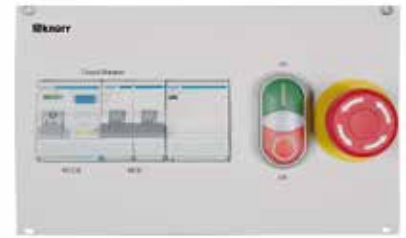

RAP20081

W	HP	HU	Model	Order no.	UP
213.02	42	3	Type 230 V, for mini distributor	04.211.052.1	1 unit
319.36	63	3	Type 400 V, for mini distributor	04.211.053.1	1 unit

Emergency STOP

- Emergency STOP switch with turn to re-set feature, 230 V, 6 A
 - By activating the emergency STOP switch, all devices in the superstructure are turned off
 - In addition to this workstation emergency STOP function, a floating break contact for looping into a room emergency STOP function is also provided. Switching capacity 230 VAC/6 A
- Material / Finish**
- Front panel: aluminium plate, 2.5 mm, painted RAL 7035 light-grey, smooth

W	HP	HU	Model	Order no.	UP
70.78	14	3	For mini distributor	04.211.043.1	1 unit



RAP20072

Dimensions in mm: W = Width
H = Height
D = Depth
h = Installation height
d = Useful depth
L = Length

HU = Standard height unit, 1 HU = 44.45 mm
HP = Horizontal pitch
OU = Office unit
19" = 482.6 mm, (ideal for 19" components in acc. with DIN 41494)
UP = Unit of packaging

Conversion: 1 inch = 25.4 mm
Replace „x“ with the number of your color choice

Mains Fuse Protection RCCB/CB 230 V

- Optimal user and equipment protection with fault current circuit breaker
- With integrated circuit breaker

- **Material / Finish**

- Front panel: aluminium plate, 2.5 mm, painted RAL 7035 light-grey, smooth

- **Technical data**

- **Input voltage**

- 230 VAC, ± 10%, max. 16A

- **Nominal current**

- 16 A, fault current, 30 mA
- 2-pole
- Trip characteristic, type B

W	HP	HU	Model	Order no.	UP
70.78	14	3	For mini distributor	04.211.042.1	1 unit



RAP20079

RCCB Safety Switch

- Optimal user and equipment protection with fault current circuit breaker

- **Material / Finish**

- Front panel: aluminium plate, 2.5 mm, painted RAL 7035 light-grey, smooth

- **Technical data**

- **Nominal current**

- 25 A,

- **Fault current**

- 30 mA
- 2-pole

W	HP	HU	Model	Order no.	UP
70.78	14	3	For mini distributor	04.211.040.1	1 unit



RAP20080

Circuit Breaker

- **Technical data**

- See below table for different versions

- **Material / Finish**

- Front panel: aluminium plate, 2.5 mm, painted RAL 7035 light-grey, smooth

W	HP	HU	Model	Order no.	UP
35.22	7	3	Circuit Breaker 1x16A Type C	04.211.041.1	1 unit
70.78	14	3	Circuit Breaker 2x16A Type B	04.211.089.1	1 unit



RAP20073

Light Switch 0/1

- Technical data**

- 2x16 A 250 V - (lit)

- Material / Finish**

- Front panel: aluminium plate, 2.5 mm, painted RAL 7035 light-grey, smooth

W	HP	HU	Model	Order no.	UP
35.22	7	3	For mini distributor	04.211.044.1	1 unit



RAP20070

Power Supply Module, Protective Contact Sockets

- Power supply field with two or four protective contact sockets for supplying mains operated devices and users
- Power supply field with three protective contact sockets for supplying mains operated devices and users
- Three safety terminals 4mm L1, N, PE

- Technical data**

- Input voltage**
 - 230 VAC
- Output voltage**
 - 230 VAC in total 16 A

- Material / Finish**

- Front panel: aluminium plate, 2.5 mm, painted RAL 7035 light-grey, smooth

W	HP	HU	Model	Order no.	UP
106.34	21	3	2x Schuko	04.211.045.1	1 unit
213.02	42	3	4x Schuko	04.211.046.1	1 unit
213.02	42	3	3x Schuko + safety terminals	04.211.084.1	1 unit
35.22	7	3	16A1~, safety terminals, L N PE	04.211.085.1	1 unit
106.68	21	3	16A3~, safety terminals, L1-3 N PE	04.211.086.1	1 unit



RAP20077



RAP200025

Dimensions in mm: W = Width
 H = Height
 D = Depth
 h = Installation height
 d = Useful depth
 L = Length

HU = Standard height unit, 1 HU = 44.45 mm
 HP = Horizontal pitch
 OU = Office unit
 19" = 482.6 mm, (ideal for 19" components in acc. with DIN 41494)
 UP = Unit of packaging

Conversion: 1 inch = 25.4 mm
 Replace „x“ with the number of your color choice

Power Supply Field, French Sockets

- Power supply field with two French sockets (UTE) for supplying mains operated devices and consumers
- **Technical data**
 - Input voltage**
 - 230 VAC
 - Output voltage**
 - 230 VAC
 - in total 16 A
- **Material / Finish**
 - Front panel: aluminium plate, 2.5 mm, painted RAL 7035 light-grey, smooth

W	HP	HU	Model	Order no.	UP
106.34	21	3	2 x UTE	04.211.047.1	1 unit
213.02	42	3	3 x UTE + safety terminals L N PE	06.101.091.1	1 unit



RAP20071

Power Supply Field, Swiss Sockets

- Power supply field with two Swiss sockets for supplying mains operated devices and users
- **Technical data**
 - Input voltage**
 - 230 VAC
 - Output voltage**
 - 230 VAC
 - in total 10 A
- **Material / Finish**
 - Front panel: aluminium plate, 2.5 mm, painted RAL 7035 light-grey, smooth

W	HP	HU	Model	Order no.	UP
106.34	21	3	For mini distributor	04.211.048.1	1 unit



RAP20069

Power Supply Module, C13

- **Technical data**
 - 3 Euro sockets, IEC 60320 C13, 10 A
 - Incl. fine-wire fuse 10 A
- **Material / Finish**
 - Front panel: aluminium plate, 2.5 mm, painted RAL 7035 light-grey, smooth

W	HP	HU	Model	Order no.	UP
70.78	14	3	For mini distributor	04.211.049.1	1 unit



RAP20078

Power Supply Module CEE

- Module with one cepex panel mounted CEE receptacle that supplies power to one or three phase appliances. Receptacles have a spring loaded lid and offer IP44. Receptacle protrudes 33mm from mounting plate. comes with 4 screws. Accepts lead wires of a cross section of 1.5 - 4mm² for 16A versions and 2.5 - 6mm² for 32A versions.

- Material / Finish**
 - Front panel: aluminium plate, 2.5 mm, painted RAL 7035 light-grey, smooth
- Technical data**
 - 19"-cassette**
 - 3 HU, 21 HP
 - Adapter connector**
 - screw-type terminals
 - Input voltage**
 - 230/400V AC
 - 50/60Hz
 - Environmental temperature range**
 - 0-40°C

W	HP	HU	Model	Order no.	UP
106.68	21	3	CEE receptacle, 5 pole, 400V 32A	04.211.080.1	1 unit
106.68	21	3	CEE receptacle, 5 pole, 400V 16A	04.211.081.1	1 unit
106.68	21	3	CEE receptacle, 3 pole, 230V 32A	04.211.082.1	1 unit
106.68	21	3	CEE receptacle, 3 pole, 230V 16A	04.211.083.1	1 unit



Sim. to picture.

RAP00093

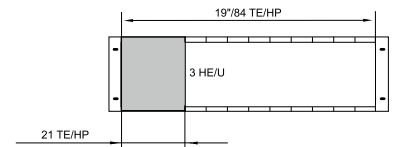

RAP00068

ESD Module

- Technical data**
 - See below table for different versions

- Material / Finish**
 - Front panel: aluminium plate, 2.5 mm, painted RAL 7035 light-grey, smooth

W	HP	HU	Model	Order no.	UP
35.22	7	3	Pole terminal 4mm, inverted, 1 MΩ	04.211.051.1	1 unit
35.22	7	3	Pole terminal 4mm, PE	04.211.087.1	1 unit



RAP20076

Dimensions in mm: W = Width
H = Height
D = Depth
h = Installation height
d = Useful depth
L = Length

HU = Standard height unit, 1 HU = 44.45 mm
HP = Horizontal pitch
OU = Office unit
19" = 482.6 mm, (ideal for 19" components in acc. with DIN 41494)
UP = Unit of packaging

Conversion: 1 inch = 25,4 mm
Replace „x“ with the number of your color choice

Ad On Module Compressed Air

- Compressed air supply module for tools, pneumatic assemblies, experiments etc.
 - Holds up to 1.6MPa (16 bar/230psi)
 - 1/8" self sealing connector
- **Material / Finish**
 - Front panel: aluminium plate, 2.5 mm, painted RAL 7035 light-grey, smooth
 - **Technical data**
 - 1 Connector 1/6"
 - Max. pressure 1.6MPa (16bar/230psi)
 - For dry air only

W	H	T	HU	Model	Order no.	UP
70.78			14	Typ PN 10/3	04.211.096.1	1 unit



Sim. to picture.

Add On Modules Video, IP, USB

- **Technical data**
 - See below table for different versions
- **Material / Finish**
 - Front panel: aluminium plate, 2.5 mm, painted RAL 7035 light-grey, smooth

W	HP	HU	Model	Order no.	UP
35.22	7	3	2x RJ 45 Cat6, shielded	04.211.050.1	1 unit
70.78	14	3	Key switch, 1 NO/NC	04.211.088.1	1 unit
35.22	7	3	1x RS232 female/female + 1x D-SUB Gender Changer	04.211.090.1	1 unit
35.22	7	3	2x VGA female	04.211.091.1	2 units
70.78	14	3	1x HDMI female/female type A	04.211.092.1	1 unit
35.22	7	3	2x BNC female 75 Ω	04.211.093.1	2 units
35.22	7	3	3x USB type A or B	04.211.094.1	3 units



Sim. to picture.

RAP20075

Front Panel Sections

- For covering free front areas
- **Material / Finish**
 - Aluminium plate, 2.5 mm, painted RAL 7035 light-grey, smooth

W	HP	HU	Model	Order no.	UP
35.22	7	3	For mini distributor	04.211.055.1	1 unit
70.78	14	3	For mini distributor	04.211.056.1	1 unit
106.34	21	3	For mini distributor	04.211.057.1	1 unit
213.02	42	3	For mini distributor	04.211.058.1	1 unit



RAP20074

Mounting Rail

- For mounting DIN rail components of the installation technology, such as fuses, terminals, relays, etc.
- "Snap-in" mounting of DIN rail components
- **Technical data**
 - Width: 70 mm
- **Material / Finish**
 - Sheet steel, zinc-passivated

W	H	D	Order no.	UP
70			04.211.106.1	1 unit

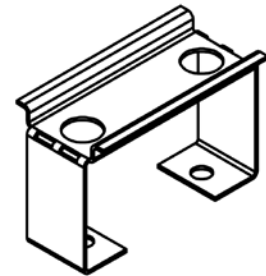

Dimensions in mm: W = Width
H = Height
D = Depth
h = Installation height
d = Useful depth
L = Length
HU = Standard height unit, 1 HU = 44.45 mm
HP = Horizontal pitch
OU = Office unit
19" = 482.6 mm, (ideal for 19" components in acc. with DIN 41494)
UP = Unit of packaging

Conversion: 1 inch = 25.4 mm
Replace „x“ with the number of your color choice

Cable Separator

- For separating data and network cables
- **Technical data**
 - Width: 60 mm
- **Material / Finish**
 - Sheet steel, zinc-passivated

W	H	D	Order no.	UP
60			04.211.105.1	4 units



EAP20022

Mounting Components Phillips head screw with cup washer

- For use with spring nut in T-slot
- For mounting front panels
- **Supply schedule**
 - 1 set of 50 pair with rosettes

W	H	D	Thread	Order no.	UP
			M5x12	05.041.203.9	50 units
			M6x14	05.041.204.9	50 units

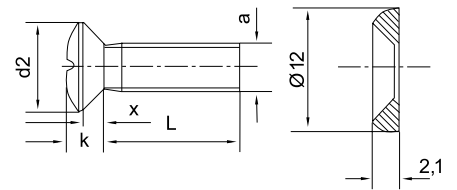

MIRO0116

Mounting Components Fixing nut, M6

- For using in the Knürr Rapomos® 19" extrusion
- Quick and easy mounting without tools
- **Material**
 - Steel, yellow chrome-plated
- **Supply schedule**
 - 1 set of 20 units

W	H	D	Thread	Order no.	UP
			M6	04.209.021.9	20 units

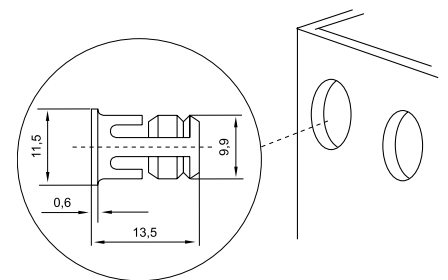

RAP00190

ESD Components

Static-Safety-Set

- Complies with DIN EN 100 015 and VDE 0104
- Includes the basic components required for equipping a workstation for electrostatic protection
- **Technical data**
 - Surface resistance in accordance with EN 100 015 $10^7 \Omega$
 - Connection contacts: press studs, 4.5 mm
- **Supply schedule**
 - Floor mat, 1200x1800 mm, wheelchair compatible
 - Desk mat 600x900 mm, heat-resistant up to 500°C
 - Earth armband, variable adjusting, 1 M Ω protective resistance on the armband side
 - Earth cable, 1.5 m with connection



SAM00346

	Model	Order no.	UP
	Static-Safety-Set	01.346.010.9	1 unit
	ESD desk mat 600x900x2	01.346.036.3	1 unit
	ESD Floor mat 1200x1800x2,5	01.346.035.3	1 unit

ESD grounding kit

- ESD grounding wire assembly
- Complete with connection button and Schuko/UTE plug for a quick and safe grounding of any console

	Model	Order no.	UP
	ESD grounding wire	04.271.070.9	1 unit

ESD Textile Wristband hypoallergenic

- **Wristband**
 - Highly elastic, washable (40°), skin-sensitive textile fabric
- **Spiral cable**
 - (Length, 1.3 m) With protective resistance (1 M Ω), ensures a safe connection for the desk mat (press studs, 4.0 mm and 4.5 mm)
- **Supply schedule**
 - 1 wrist connection armband
 - 1 spiral cable

	Order no.	UP
	01.346.033.9	1 unit



DAC00064



DAC00065

WARRANTY & MAINTENANCE PACKAGES

ESSENTIAL



SCOPE OF SERVICES:

- **24/7 service hotline** – available at all times for rapid support from our experts
- **Reliable fault rectification** – service call-out within a maximum of 10 working days
- **Replacement parts included** – no additional material costs in the event of a fault

Knürr® Warranty – ESSENTIAL

Description	Order-nr.
Warranty 24 months (2Y)	94.000.024.0
Warranty 36 months (3Y)	94.000.036.0
Warranty 48 months (4Y)	94.000.048.0
Warranty 60 months (5Y)	94.000.060.0

Knürr® proactive on-site maintenance

Description	Order-nr.
Maintenance	94.001.000.0
Maintenance with DGUV/V3	94.001.000.0000001
Maintenance with Thermoscan	94.001.000.0000002

*In accordance with Knürr warranty terms and conditions

PREMIUM



SCOPE OF SERVICES:

- **24/7 service hotline** – available at all times for rapid support from our experts
- **Reliable fault rectification** – service call-out within a maximum of 5 working days
- **Replacement parts included** – no additional material costs in the event of a fault
- **On-site repairs included** – travel costs and labour costs are already included in the service package

Knürr® Warranty – PREMIUM

Description	Order-nr.
Warranty 24 months (2Y)	94.000.024.1
Warranty 36 months (3Y)	94.000.036.1
Warranty 48 months (4Y)	94.000.048.1
Warranty 60 months (5Y)	94.000.060.1
Warranty 72 months (6Y)	94.000.072.1
Warranty 84 months (7Y)	94.000.084.1
Warranty 96 months (8Y)	94.000.096.1
Warranty 108 months (9Y)	94.000.108.1
Warranty 120 months (10Y)	94.000.120.1

Ergonomically designed products and solutions from a single source

Knürr GmbH is one of the world's leading specialists for innovative solutions in safety- and performance-critical control centres and command rooms. For more than 50 years, the company, headquartered in Germany, has been delivering tailor-made and fully integrated workspace systems designed for demanding 24/7 operations.

Learn more about Knürr solutions and services at www.knuerr.com

Knürr GmbH
 Mariakirchener Straße 38
 94424 Arnstorf
 Germany
 T +49 8723 28 0
 F +49 8723 28 138
 info@knuerr.com
 www.knuerr.com



knürr
World of control rooms

knuerr.com | **Knürr GmbH**, Mariakirchener Straße 38, 94424 Arnstorf, Germany ID-Nr. DE 363797731

© 2026 Knürr GmbH. All rights reserved. Knürr® and the Knürr logo are trademarks or registered trademarks of Knürr GmbH. All other names and logos referred to are trade names, trademarks or registered trademarks of their respective owners. While every precaution has been taken to ensure accuracy and completeness herein, Knürr GmbH assumes no responsibility, and disclaims all liability, for damages resulting from use of this information or for any errors or omissions. Specifications are subject to change without notice.

09.991.116.0.000001 • EN • #10065 Version 19.03.2026